

PRODUCT CATALOG

Barn Door & Closet Door
(2024-2025)



**DOORS, SYSTEMS
& HARDWARE**

Barn Door Slabs

Hollow Core | Primed Ready to Paint

Create a new look in any home with a barn door that is easy to install! A hollow core door is lighter than a traditional solid core barn door allowing for easier transport and installation. A barn door brings instant warmth and charm to any dining room, kitchen, study or bedroom.

Features & Benefits

- Hollow-core composite resists warping, shrinking and cracking
- The reduced weight makes the door easier to install vs. traditional solid core barn doors
Installation no longer requires two people to lift the door on to the track (less than 50lbs)
- Ready to paint primed white finish
- Can be installed using front mount or top mount door barn door hardware

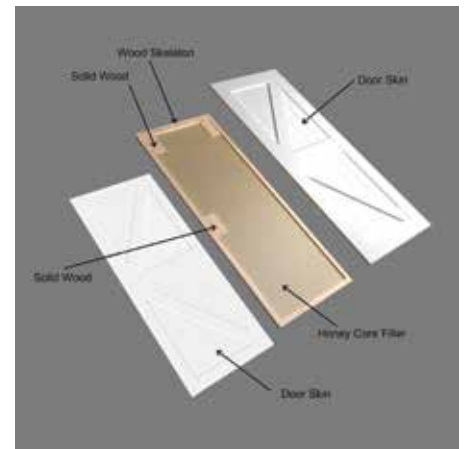

STONE K-DESIGN
36" × 84" × 1-3/8"
HC052P09PR1PRE36084



CENTRAL SQUARE
37" × 84" × 1-3/8"
RHCS-37



CLASSIC 6-PANEL
37" × 84" × 1-3/8"
RHCLP-37



1-PANEL
37" × 84" × 1-3/8"
RHTSP-37-V

Barn Door Slabs

Solid Core | Primed Ready to Paint

Create a new look in any home with a barn door that lasts a lifetime! These solid core barn doors are primed in white with the option to paint any color to match or compliment your room decor. A barn door brings instant warmth and charm to any dining room, kitchen, study or bedroom.

Features & Benefits

- Durable Construction: The solid engineered wood core resists cracking or warping due to humidity changes, ensuring long-lasting performance
- Versatile Finish: Prefinished in a white primer, this door can also be painted to match your specific decor
- Install using front mount door barn door hardware system



1-PANEL
Primed White
36" x 84" x 1-3/8"
BD042M09MW1MWE36084



SOLID CORE K-DESIGN
Primed White
36" x 84" x 1-3/8"
BD052M09MW1MWE36084



PURE
Primed White
33" x 84" x 1 | 37" x 84" x 1
RDPUR-33 | RDPUR-37



CHEVRON
Primed White
33" x 84" x 1-3/8" | 37" x 84" x 1-3/8"
RDCHV-33 | RDCHV-37

Barn Door Slabs

Continental Collection | Prefinished Solid Core

ACME's Continental sliding barn doors with glass inserts blend openness and natural lighting. Inspired by the simplicity of Scandinavian design, these glass barn doors bridge classic to contemporary styles and décor. Our Continental Collection welcomes natural light and offers a unique focal point for any interior space. Choose completely transparent glass to visually connect and define the spaces on either side of the door. Or, select frosted glass when you want to maintain openness, while adding privacy.



CRISTO 1-LITE
in Iron Age

36" x 84" x 1-3/8"
BD054W09IA1TGE36084



HALL 3-LITE
in Iron Age

36" x 84" x 1-3/8"
BD061W09IA3TGE36084



PROVINCIAL 8-LITE
in White

36" x 84" x 1-3/8"
BD137W12BWITGE36084



3-LITE
in White Woodgrain

37" x 84" x 1-3/8"
RV3LW-37

Barn Door Slabs

Brownstone Collection | Prefinished Solid Core

Acme Renin's Brownstone engineered solid wood barn doors are modern, durable, meticulously built and carefully prefinished in a variety of distinct colors, textures and finishes. The subtle design of these engineered sliding barn doors includes such authentic features as knots and fine grain detail. Our Brownstone Collection's engineered materials are extremely sturdy, maintain their shape and don't require tedious maintenance, painting or staining. Our easy-to-maintain doors will continue to deliver the look and performance you've come to expect year after year.

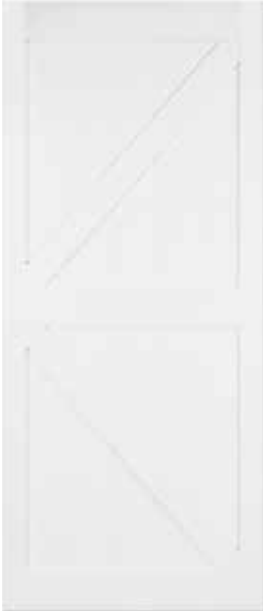

STONE K-DESIGN in Bright White

36" × 84" × 1-3/8"
BD052W09BW1BWE36084
42" × 84" × 1-3/8"
BD052W09BW1BWE42084



STONE K-DESIGN in Silver Oak

36" × 84" × 1-3/8"
BD052W09GY1GYE36084
42" × 84" × 1-3/8"
BD052W09GY1GYE42084



STONE K-DESIGN in Barnwood Oak

36" × 84" × 1-3/8"
BD052W09DW1DWE36084

Barn Door Slabs

Brownstone Collection | Prefinished Hollow Core

Acme's Brownstone hollow core barn door slabs are prefinished featuring a durable, scratch resistant finish which is lightweight and easy to hang while saving time and money with no painting, staining or mess.



SHACK

33" x 84" x 1-3/8" | 37" x 84" x 1
RDCBH-33 | RDCBH-37



SUMMIT - Brown

37" x 84" x 1-3/8"
RHSM37-B



SUMMIT - Grey

37" x 84" x 1-3/8"
RHSM37-G



ARROW

in Black Brown

36" x 84" - BD135W09MB1MBE36084
36" x 88" - AW135WT1CA1CAE36088
42" x 88" - AW135WT1CA1CAE42088



BISTRO - CHALKBOARD

33" x 84" | 37" x 84"
RDBIS-33 | RDBIS-37

Barn Door Slabs

Heritage Collection | Unfinished Pine

ACME's barn door slabs are available in a selection of rustic designs to complement your home's unique style. These beautifully designed doors can be paired with our traditional barn door hardware. Extra wide doors ensure the opening is fully covered. Multi-layer wood construction which ensures that the doors remain intact despite seasonal fluctuations of humidity. Ready to stain or paint knotty pine wood doors. Can be installed using front mount or top mount door barn door hardware. Extra wide doors for full coverage of door opening.



SALINAS Z-DESIGN
Natural Pine Stain/Paint Ready
36" x 84" x 1-3/8"
BDD053B09PNIPNE36084



CHALET Z-DESIGN
33" x 84" x 1-3/8" | 37" x 84" x 1-3/8"
42" x 84" x 1-3/8"
RDC38-33 | RDC38-37



ARTISAN K-DESIGN
33" x 84" x 1-3/8" | 37" x 84" x 1-3/8"
42" x 84" x 1-3/8"
RDK38-33 | RDK38-37 | RDK38-42



RUSTIC
18" x 84" x 1-3/8" | 26" x 84" x 1-3/8"
33" x 84" x 1-3/8" | 37" x 84" x 1-3/8"
42" x 84" x 1-3/8"
RDR38-18 | RDR38-26 | RDR38-33
RDR38-37 | RDR38-42



SHAKER 3-LITE
33" x 84" x 1-3/8" | 37" x 84" x 1-3/8"
RDSHK-33 | RDSHK-37



COUNTRY
33" x 84" x 1-3/8" | 37" x 84" x 1-3/8"
42" x 84" x 1-3/8"
RDCNY-33 | RDCNY-37 | RDCNY-42



RANCH 2-LITE
33" x 84" x 1-3/8" | 37" x 84" x 1-3/8"
42" x 84" x 1-3/8"
RDE38-33 | RDE38-37 | RDE38-42



MAGNOLIA DOUBLE X
33" x 84" x 1-3/8" | 37" x 84" x 1-3/8"
42" x 84" x 1-3/8"
RDMAG-33 | RDMAG-37 | RDMAG-42



STATION
33" x 84" x 1-3/8" | 37" x 84" x 1-3/8"
42" x 84" x 1-3/8"
RDSTA-33 | RDSTA-37 | RDSTA-42



FULL-CHECK
33" x 84" x 1-3/8" | 37" x 84" x 1-3/8"
42" x 84" x 1-3/8"
RDFCK-33 | RDFCK-37 | RDFCK-42

Barn Door Slabs

Heritage Collection | Unfinished Pine

ACME's barn door slabs are available in a selection of rustic designs to complement your home's unique style. These beautifully designed doors can be paired with our traditional barn door hardware. Extra wide doors ensure the opening is fully covered. Multi-layer wood construction which ensures that the doors remain intact despite seasonal fluctuations of humidity. Ready to stain or paint knotty pine wood doors. Can be installed using front mount or top mount door barn door hardware. Extra wide doors for full coverage of door opening.



HALF-CHECK

33" x 84" x 1-3/8" | 37" x 84" x 1-3/8"
42" x 84" x 1-3/8"
RDHCK-33 | RDHCK-37 | RDHCK-42



CRAFTSMAN

33" x 84" x 1-3/8" | 37" x 84" x 1-3/8"
42" x 84" x 1-3/8"
RDCNY-33 | RDCNY-37 | RDCNY-42



BARREL

33" x 84" x 1-3/8" | 37" x 84" x 1-3/8"
42" x 84" x 1-3/8"
RDBRL-33 | RDBRL-37 | RDBRL-42



6-PANEL

33" x 84" x 1-3/8" | 37" x 84" x 1-3/8"
42" x 84" x 1-3/8"
RD6PA-33 | RD6PA-37 | RD6PA-42



CELLAR

33" x 84" x 1-3/8" | 37" x 84" x 1-3/8"
RDCHM-33 | RDCHM-37



5-LITE

33" x 84" x 1-3/8" | 37" x 84" x 1-3/8"
42" x 84" x 1-3/8"
RDFLI-33 | RDFLI-37 | RDFLI-42



MILAN

33" x 84" x 1-3/8" | 37" x 84" x 1-3/8"
RDMIL-33 | RDMIL-37



1-LITE

33" x 84" x 1-3/8" | 37" x 84" x 1-3/8"
RDDOLI-33 | RDDOLI-37



REFLEX MIRROR

33" x 84" x 1-3/8" | 37" x 84" x 1-3/8"
RDRFX-33 | RDRFX-37



ARTIS

33" x 84" x 1-3/8" | 37" x 84" x 1-3/8"
RDART-33 | RDART-37



HERRINGBONE in Stained Grey

36" x 84" x 1-3/8"
BD059C01NSINSE36084

Barn Door Kits with Bent Strap Hardware

Hollow Core | Primed Ready to Paint or Stain

Create a new look in any home with a barn door that is easy to install! A hollow core door is lighter than a traditional solid core barn door allowing for easier transport and installation. A barn door brings instant warmth and charm to any dining room, kitchen, study or bedroom.

Features & Benefits

- Hollow-core composite resists warping, shrinking and cracking
- The reduced weight makes the door easier to install vs. traditional solid core barn doors
Installation no longer requires two people to lift the door on to the track (less than 50lbs)
- Ready to paint primed white finish or Ready to stain (Walnut Veneer model)
- Can be installed using front mount or top mount door barn door hardware
- Matte Black hardware for easy installation



STONE K-DESIGN
in Primed White
36" x 84"
HC052P01PR1PRE36084

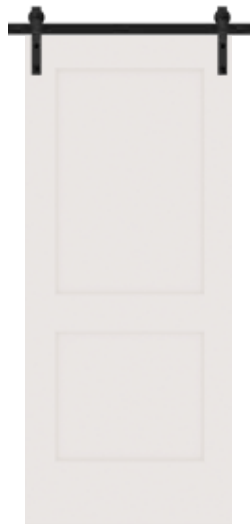

CENTRAL SQUARE
in Primed White
37" x 84"
KMCTTSP-37BL



TIMES SQUARE 1-PANEL
in Primed White
37" x 84"
KMCTCSP-37BL



CLASSIC 6-PANEL
in Primed White
37" x 84"
KMINCLP-37BL-V



MISSION 3-PANEL
in Primed White
37" x 84"
HC070P01PR1PRM37084



CHEVRON
in Primed White
36" x 84"
HC065P01PR1PRE36084



STONE K-DESIGN
in Walnut Veneer
36" x 84" x 1-3/8"
HC052B01WN1WNE3684

Barn Door Kits with Bent Strap Hardware

Solid Core | Primed Ready to Paint

ACME's Brownstone engineered solid wood barn doors are modern, durable, meticulously built and primed white, meaning you can leave as is or paint to match your room decor. Our ACME Collection's engineered materials are extremely sturdy, maintain their shape and don't require tedious maintenance. Our easy-to-maintain doors will continue to deliver the look and performance you've come to expect year after year.



1-PANEL DESIGN
in Primed White

36" x 84"
BDD042M01MW1MWE36084



STONE K BRACE DESIGN
in Primed White

36" x 84" - BD052C01MW1MWE36084
42" x 84" - BD052C01MW1MWE42084

Barn Door Kits with Bent Strap Hardware

Continental Collection | Solid Core Prefinished

ACME's Continental sliding barn doors with glass inserts blend openness and natural lighting. Inspired by the simplicity of Scandinavian design, these glass barn doors bridge classic to contemporary styles and décor. Our Continental Collection welcomes natural light and offers a unique focal point for any interior space. Choose completely transparent glass to visually connect and define the spaces on either side of the door. Or, select frosted glass when you want to maintain openness, while adding privacy.

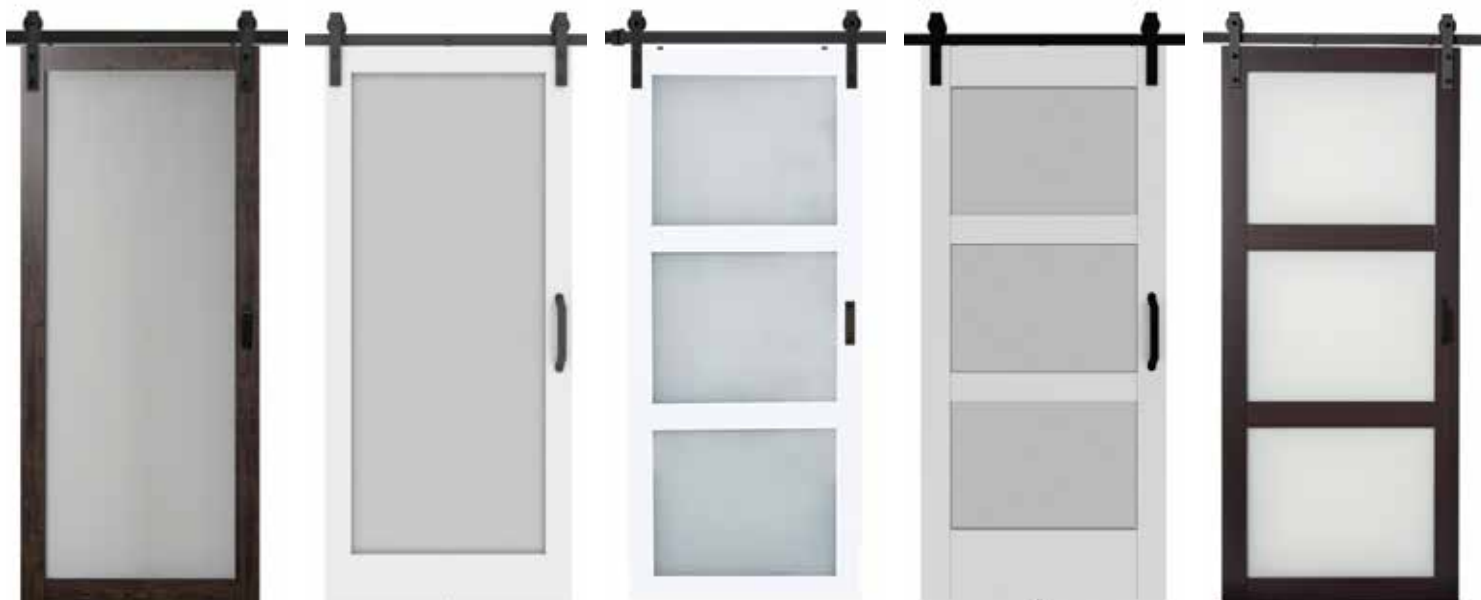

CRISTO 1-LITE
in Iron Age
36" x 84" x 1-3/8"
BD054W01A1TGE36084

1-LITE
in White Wood Grain
37" x 84" x 1-3/8"
RVRR1LW-37BL-E

HALL 3-LITE
in Bright White
36" x 84" x 1-3/8"
BD061W01BW3TGE36084

3-LITE
in White Wood Grain
37" x 84" x 1-3/8"
RVRR3LW-37BL

HALL 3-LITE
in Espresso
36" x 84" x 1-3/8"
BD061W01ES3TGE36084



HALL 3-LITE
in Iron Age
36" x 84" x 1-3/8"
BD061W01A3TGE36084

4-LITE
in Bright White
36" x 84" x 1-3/8"
RVRR4LPW-37BL

PAVILION 5-LITE
in Iron Age
36" x 84" x 1-3/8"
BD062W01A5TGE36084

PAVILION 5-LITE
in Bright White
36" x 84" x 1-3/8"
BD062W01BW5TGE36084

Barn Door Kits with Bent Strap Hardware

Brownstone Collection | Solid Core Prefinished

ACME's Brownstone engineered solid wood barn doors are modern, durable, meticulously built and carefully prefinished in a variety of distinct colors, textures and finishes. The subtle design of these engineered sliding barn doors includes such authentic features as knots and fine grain detail. Our ACME Collection's engineered materials are extremely sturdy, maintain their shape and don't require tedious maintenance, painting or staining. Our easy-to-maintain doors will continue to deliver the look and performance you've come to expect year after year.



SAGRADA DOUBLE X-DESIGN
in Gunstock
36" x 84" x 1-3/8"
BD060W01G01G0E36084



STONE K-DESIGN
in Gunstock
36" x 84" x 1-3/8"
BD052W01G01G0E36084



STONE K-DESIGN
in Off White
36" x 84" x 1-3/8"
BD052W01WTIWE36084



STONE K-DESIGN
in Grey
37" x 84" x 1-3/8"
RVRRK3G-37BL



STONE K-DESIGN
in Iron Age
36" x 84" x 1-3/8"
BD052C01AG1AGE36084



SALINAS Z-DESIGN
in Iron Age
36" x 84" x 1-3/8"
BD053W01A1IAE36084



HERRINGBONE
in Grey
37" x 84" x 1-3/8"
RVRRHBG-37BL-E



HERRINGBONE
in Bright White
37" x 84" x 1-3/8"
RVRRHBW-37BL-E

Barn Door Kits with Bent Strap Hardware

Solid Core | Prefinished & Ready To Finish

Acme's barn doors not only look beautiful but are constructed to meet the demands of today's busy interior spaces. The solid engineered wood core is super stable makes this a worry free door. These beautifully designed doors are paired with our matte black bent strap barn door hardware kits.



STONE K-DESIGN
in Unfinished Pine

36" x 84" x 1-3/8"
BD052B01PNIPNE36084



SALINAS Z-DESIGN
in Unfinished Pine

36" x 84" x 1-3/8"
BD053C01PNIPNE36084
42" x 84" x 1-3/8"
BD053C01PNIPNE42084



HERRINGBONE
in Stained Grey

36" x 84" x 1-3/8"
BD059C01NSTINSE36084



GLACIER DESIGN
in Frosted Tempered Glass

33" x 84" x 1-3/8" - KMGLGCF-33BN
37" x 84" x 1-3/8" - KMGLGCF-37BN

Tempered Frosted Glass Complete Barn Door Kit

A barn door brings instant warmth and charm to any dining room, kitchen, study or bedroom. The Glacier door offers you our most contemporary look. This door plays with light, reflection and transparency, it will appeal to lovers of contemporary style.

Features & Benefits

- Tempered frosted glass door, intimacy level 7
- Pre-drilled door for easy trolleys and handle installation
- Brushed stainless steel durable finish for interior applications
- Matching finish handle included
- Thickness: 8mm

Barn Door Kits with Top Mount Hardware

Industrial Collection | Aluminum Frame Barn Door Kit

Inspired by former industrial buildings turned lofts in New York's iconic Tribeca neighborhood, our barn doors offer functional and industrial charm to your space. This nostalgic design encompasses the contemporary flair of our aluminum black framed design combined with tempered frosted glass panes ensuring privacy while still allowing natural light to enter the room. These space-saving barn doors are a perfect complement to any decor style.



6-LITE
Matte Black Finish
36" x 84" x 1"
BD073A14BA1TGE36084



8-LITE
Matte Black Finish
36" x 84" x 1"
BD074A14BA1TGE36084

Features & Benefits

- Trackless door design keeps floor opening clear and free of hazard for easy entry
- Contemporary 6-Lite and 8-Lite design complements any decor style
- Tempered frosted glass is durable and easy to maintain while ensuring privacy in your space
- Pre-finished lightweight aluminum frame in matte black finish glides easily across the track
- Requires no priming, painting or staining making it quick and easy to install and enjoy
- Includes all hanging hardware and handle

Barn Door Kits with Top Mount Hardware

Industrial Collection | Aluminum Frame Barn Door Kit

Instantly modernize your living space with the metal sliding barn doors from the Metro collection. The combination of contemporary design with an industrial influence will be sure to make a statement in any room of your home. Using only quality materials such as tempered glass and powder coated steel frame, paired with sturdy rail system, this door will help to convert your living space into a functional masterpiece.

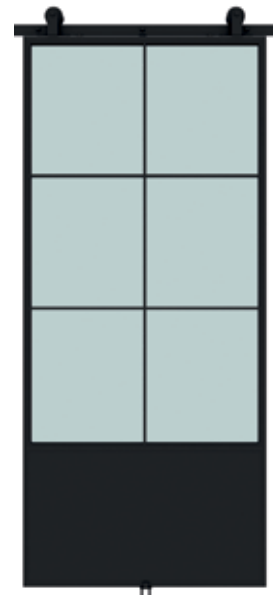

BROADWAY
37" x 84" x 1-3/16"
KMCTBWF-37BL



CONCORDE
37" x 84" x 1-3/16"
KMCTCCF-37BL

Features & Benefits

- Steel door with durable black powder coated finish for interior applications
- Tempered frosted glass, intimacy level 7 or tempered clear glass, intimacy level 0
- Fully assembled door, no finishing required
- Door dimensions: Width 37" - Height 84" - Thickness 1 3/16"
- Sliding rail dimensions: Length 78 3/4" - Height 4 3/4" - Diameter 2 3/4"
- Premium ball-bearing ultra-quiet roller
- Steel with durable black powder coated finish for interior applications
- Door kit is installed over finished opening up to 36" wide x 80 1/2" height
- Handle sold separately

Barn Door Kits with Top Mount Hardware

Industrial Collection | Steel Frame Barn Door Kit

Instantly modernize your living space with the metal sliding barn doors from the Metro collection. The combination of contemporary design with an industrial influence will be sure to make a statement in any room of your home. Using only quality materials such as tempered glass and powder coated steel frame, paired with sturdy rail system, this door will help to convert your living space into a functional masterpiece.

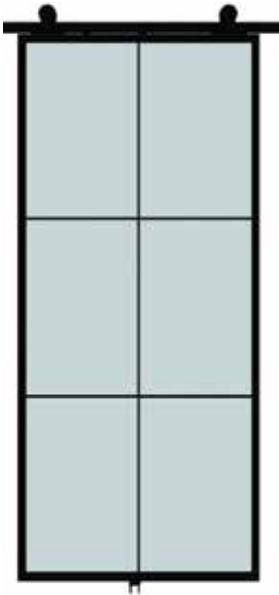

LEXINGTON
37" x 84" x 1-3/16"
KMCTLXF-37BL-E

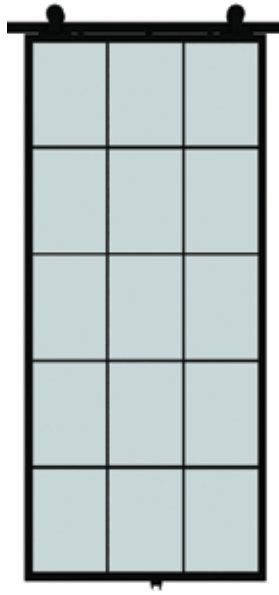

QUEEN'S 15-LITE
37" x 84" x 1-3/16"
KMCTQNF-37BL-E

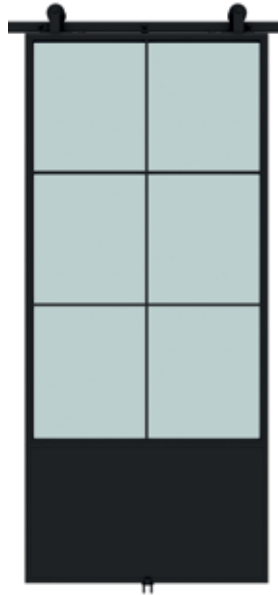

BROADWAY 6-LITE
37" x 84" x 1-3/16"
KMCTBWF-37BL

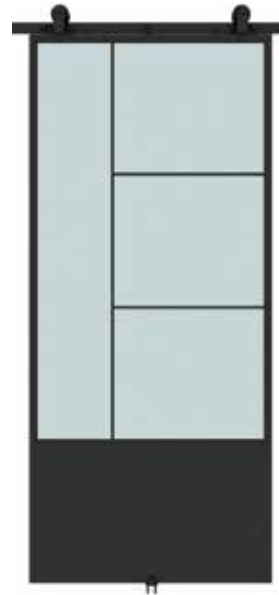

OPERA 4-LITE
37" x 84" x 1-3/16"
KMCTOPR-37BL

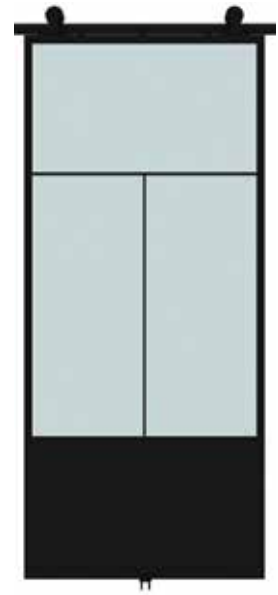

NATION 3-LITE
37" x 84" x 1-3/16"
KMCTNTC-37BL

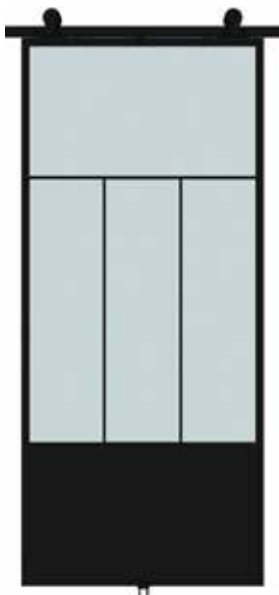

DIVISION 4-LITE
37" x 84" x 1-3/16"
KMCTDVC-37BL

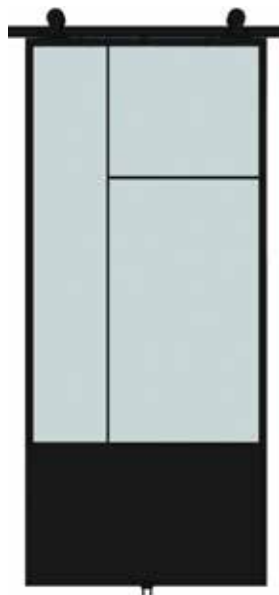

CICERO 3-LITE
37" x 84" x 1-3/16"
KMCTCOF-37BL

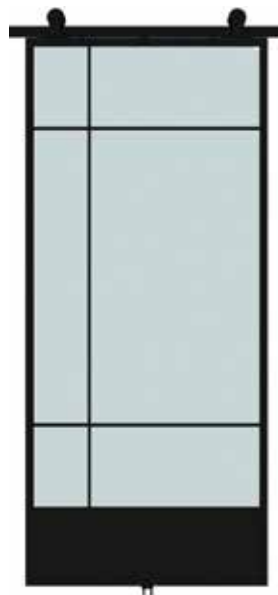

BASTILLE 6-LITE
37" x 84" x 1-3/16"
KMCTBTF-37BL



CONCORDE 3-LITE
37" x 84" x 1-3/16"
KMCTCCF-37BL

Barn Door Kits with Top Mount Hardware

Easy Build | Ready to Build Kit

ACME's Easy-Build Barn Door Kits are the perfect DIY barn door package with everything you need to successfully complete this do-it-yourself door project. Ready to put in your car and take home, our step-by-step instructions show how to install a barn door quickly and easily. Our Easy-Build Collection can transform your doorways with design styles ranging from rustic to modern in conveniently pre-finished options. Whichever barn door design you choose, you'll be proud to take credit for creating this impressive, cost-effective focal point in your home.



AUTHENTIC
in Bright White

36" x 84" x 1"
BD069W01BW1BWE36084



AUTHENTIC
in Iron Age

37" x 84" x 1"
BD069W01A1AE36084



LANGLEY
in Graphite Grey

36" x 84" x 1-3/8"
BD136K01GG1GGE36084

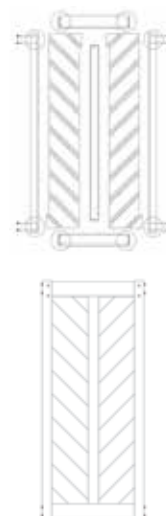

STONE K-DESIGN
in Bright White

36" x 84" x 1-3/8"
BD052K01BW1BWE36084

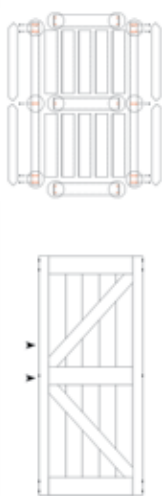

SALINAS Z-DESIGN
in Unfinished Pine

36" x 84" x 1-3/8"
BD053K01PN1PNE36084



PAVILION 5-LITE
in Bright White

36" x 84" x 1-3/8"
BD062K01BW5TGE36084

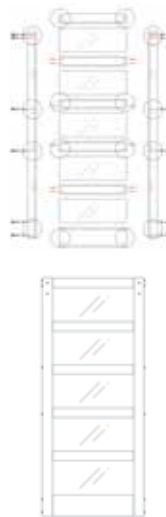

Barn Door Hardware

Spectrum Barn Door Hardware | 250 lb



Spectrum Bent Strap



BRONZE
78 3/4" Track | BD102K-07800-BR
96" Track | BD102K-09600-BR



STAINLESS STEEL
78 3/4" Track | BD102K-07800-SS
96" Track | BD102K-09600-SS



MATTE BLACK
78 3/4" Track | BD102K-07800-MB
96" Track | BD102K-09600-MB



RAW STEEL
78 3/4" Track | BD205-07800-RW
96" Track | BD205-09600-RW



BRIGHT GOLD
78 3/4" Track | SB78RR-BG-ECOM
96" Track | SB96RR-BG-ECOM

Spectrum Straight Strap



BRONZE
78 3/4" Track | BD100K-07800-BR
96" Track | BD100K-09600-BR



STAINLESS STEEL
78 3/4" Track | BD100K-07800-SS
96" Track | BD100K-09600-SS



MATTE BLACK
78 3/4" Track | BD100K-07800-MB
96" Track | BD100K-09600-MB

Spectrum Top of Door Strap



BRONZE
78 3/4" Track | BD101K-07800-BR
96" Track | BD101K-09600-BR



STAINLESS STEEL
78 3/4" Track | BD101K-07800-SS
96" Track | BD101K-09600-SS



MATTE BLACK
78 3/4" Track | BD101K-07800-MB
96" Track | BD101K-09600-MB

Spectrum Flat Track Replacement



Matte Black
78 3/4" Track | BD5000-07800-MB
96" Track | BD5000-09600-MB



Stainless Steel
78 3/4" Track | BD5000-07800-SS
96" Track | BD5000-09600-SS



Bronze
78 3/4" Track | BD5000-07800-BR
96" Track | BD5000-09600-BR

For more Replacement Hardware information & pricing, see our 2024 Price List

Barn Door Hardware

Adding the finishing touches to any renovation or decorating project can complete a homes look. A sliding barn door kit plays an important role in enhancing the style of a space. With a multitude of choices available, factors to consider can include how well a particular style or finish complements the overall design theme and how the hardware will function within the space relative to other important decor items. Sliding barn door hardware is like adding jewelry to a room, the personality that makes the room reflect the home owners style and interests.

Spectrum Barn Door Hardware | 250 lb



SPECTRUM ARROW BENT STRAP
78 3/4" TRACK

Matte Black | SB78MR-BL



SPECTRUM WAGON BENT STRAP
78 3/4" TRACK

Matte Black | BD197-07800-MB
Satin Nickel | BD204-07800-SN
Raw Steel | BD208-07800-RW



SPECTRUM WAGON WHEEL TOP MOUNT
78 3/4" TRACK

Matte Black | BD196-07800-MB
Satin Nickel | BD203-07800-SN
Raw Steel | BD207-07800-RW



SPECTRUM HORSESHOE BENT STRAP
78 3/4" TRACK

Matte Black | BD195-07800-MB
Satin Nickel | BD199-07800-SN
Raw Steel | BD206-07800-RW



SPECTRUM CACHE TOP MOUNT MINI
78 3/4" TRACK

Matte Black | SB78SR-BL

Barn Door Hardware

Adding the finishing touches to any renovation or decorating project can complete a homes look. A sliding barn door kit plays an important role in enhancing the style of a space. With a multitude of choices available, factors to consider can include how well a particular style or finish complements the overall design theme and how the hardware will function within the space relative to other important decor items. Sliding barn door hardware is like adding jewelry to a room, the personality that makes the room reflect the home owners style and interests.

Spectrum Barn Door Hardware | 125lb - 250 lb



**SPIRIT 2-PIECE
BENT STRAP | 125 LB
78" TRACK**
2-Piece | SR78I2-BL
1-Piece | SB78R2-BL



**CADIUM
BENT STRAP | 150 LB**
78" Track | BD202K-07800-MB
96" Track | BD202K-09600-MB



**CITI ROUNDED
BENT STRAP | 250 LB (WHITE)
78" TRACK**
Matte Black | SB78CI-WT



**CHARIOT 15"
BENT STRAP | 250 LB**
Matte Black | SB78CH-BL



**DIAMOND
BENT STRAP | 125 LB**
Matte Black | SB78DI-BL

Barn Door Hardware

Discover the elegance and functionality of Acme's Tubular Barn Door Hardware, available in four distinct styles to suit any decor. Each style features high-quality steel construction, ensuring durability and smooth operation for years to come. The sleek, modern designs not only save space but also add a contemporary touch to your home or office. Easy to install with included mounting hardware, these barn door kits provide a seamless transition between rooms. Styled in stainless steel finish to perfectly match your aesthetic while enjoying the benefits of effortless sliding doors.

Tubular Track Design | 250 lb



MINI LOFT TUBULAR | 250 LB
78 3/4" TRACK
White | SL78MR-WT



LOFT TUBULAR | 250 LB
78 3/4" TRACK
Stainless Steel | SL78RR-BN



URBANO TUBULAR | 250 LB
78 3/4" TRACK
Stainless Steel | SL78UB-BN



G-LOFT TUBULAR | 250 LB
78 3/4" TRACK
Stainless Steel | SL78GR-BN

Barn Door Hardware

Easy Latch Privacy Barn Door Hardware Kit

ACME's patented Barn Door Easy Latch Hardware is designed to give you the privacy you need in your home without compromising style or function. Our Easy Latch is compatible with most flat track barn door hardware systems making this a simple DIY installation. Ease of operation makes Easy Latch ADA compliant which is ideal for many commercial and hospitality applications.



MATTE BLACK FINISH
BDF8000-MB

Features & Benefits

- The Easy Latch is surface mounted without the need to remove the door making the installation process quick and easy
- The locking bar easily mounts to the edge of the door and does not require drilling into your wall or door jamb eliminating any damage to your existing opening
- The easy to operate, American Disability Act (ADA) compliant lever secures the door from the inside providing privacy control in applications such as an ensuite bathroom or office



Barn Doors Hardware

Bi-Parting Barn Door Hardware Kits

ACME's innovative cable-driven synchronizing technology enables the simultaneous opening and closing of bi-parting doors with just one hand. By pulling on one handle, both doors glide open or closed in unison. Add functionality and versatility with this easy-to-install hardware offering.

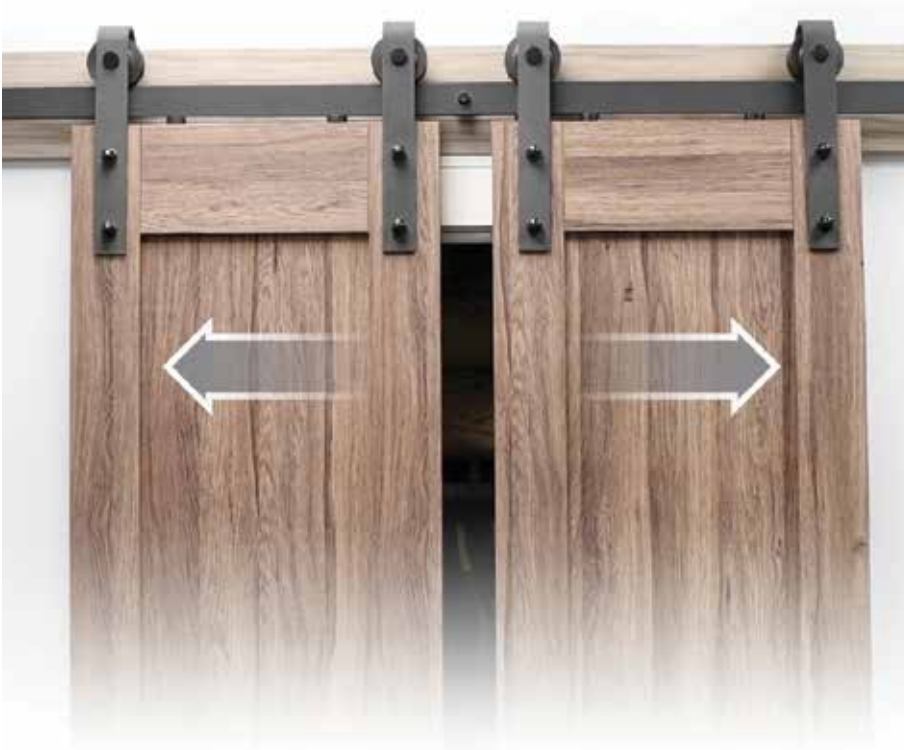

Matte Black Finish

- 78-3/4" Track Length - BD910-07800-MB
- 78-3/4" Track Extension Kit - BD910-07800-MBEXT
- 83-7/8" Track Length - BD910-08300-MB
- 83-7/8" Track Extension Kit - BD910-08300-MBEXT
- 96" Track Length - BD910-09600-MB

Features & Benefits

- Synchronizing Barn door hardware kit—allows for simultaneous opening and closing of two bi-parting doors. An added convenience, instead of having to open each side at a time
- Can be used with existing doors or as a new installation
- Available in 78-3/4", 83-7/8" or 96" track lengths. For a pair of doors larger than 24" the additional track extension hardware kit is needed
- 78-3/4" Track is compatible with (x2) 12", (x2) 15" and (x2) 18" wide doors. For (x2) 36" wide doors the 78-3/4" Track Extension Hardware Kit is also needed
- 83-7/8" Track is compatible with (x2) 21" wide doors. For (x2) 42" wide doors the 83-7/8" Track Extension Hardware Kit is also needed
- 96" Track is compatible with (x2) 24" wide door slabs
- Doors sold separately



Barn Doors Hardware

Single Track Bypass Barn Door Hardware Kits

ACME's innovative single-track bypass barn door hardware kit eliminates the bulk of a traditional bypassing system by removing one of the tracks which allows your doors to be closer to the wall. This provides more privacy and space within your room.



Matte Black Finish

78" Track Length - BD280K-07800-MB

96" Track Length - BD280K-09600-MB



Satin Nickel Finish

78" Track Length - BD280K-07800-SN

96" Track Length - BD280K-09600-SN

Features & Benefits

- Hardened Steel Hardware with offset hangers designed to allow two panels to bypass over an opening on a single flat track
- Each kit includes all hanging hardware for panels weighing a combined 250 lb
- 78-3/4" Track is compatible with (x2) 12", (x2) 15", (x2) 18", (x2) 30" and (x2) 36" wide door slabs
- 96" Track is compatible with (x2) 42" wide door slabs
- Doors sold separately

Barn Doors Hardware

Spectrum Bypass Barn Door Bracket Kit

When wall space is an issue, the bypass kit will allow two barn doors to independently travel across two tracks and not require extra clearance. The double barn door hardware kit allows for one door to slide over another making it perfect for closets, pantries, or possibly even multiple openings on the same wall.



Features & Benefits

- Allows double barn doors to travel independently across two tracks
- Ideal when there is not enough wall space to allow two doors to slide across the wall
- Barn Door Hardware Kits sold separately
- Available in 78-3/4" (5 Brackets) and 96" (6 Brackets)

Bypass Bracket | 78 3/4" Track | 96"

Matte Black | BD670-07800-MB

Satin Nickel | BD670-07800-SN

Matte Black | BD670-09600-MB

Satin Nickel | BD670-09600-SN



Barn Doors Hardware

Bifold Barn Door Hardware Kits

ACME has given new life to the traditional bifold doors by developing a system which incorporates the aesthetics of a barn door but with the functionality of a bifold system.



Matte Black Finish

48" Track Length - BD952-04800-MB
78" Track Length - BD954-07800-MB

Duet Collection Bipart/Bifold Barn Door Slabs



CHEVRON DESIGN in Ashen White

(2) × 21" × 84" × 1 3/8"
BD124WT1AW2AWE42084



CHEVRON DESIGN in Ashen Gray

(2) × 21" × 84" × 1 3/8"
BD124WT1AG2AGE42084



1-LITE DESIGN Bright White

(2) × 21" × 84" × 1 3/8"
BD124WT1BW2TGE42084

Features & Benefits

- Bifold system does not require extra wall space as the entire track slides within the opening
- This gives your room a major design upgrade while incorporating function and space savings
- Kit includes two steel barn door hangers and 48" or 78-3/4" track, finished in matte black
- 48" Track is compatible with (×2) 12", (×2) 15", and (×2) 18" wide door slabs
- 78-3/4" Track is compatible with (×4) 12", (×4) 15", and (×4) 18" wide door slabs
- Doors sold separately

Barn Doors Hardware

Easy Clip Soft Close Hardware Kits

ACME's universal Easy Clip Soft Close attachment is designed to install quickly and discretely onto most flat track barn door hardware kits. This patent-pending low profile innovation is hidden behind the track and can be easily installed in minutes to any new or previously mounted barn door kit. The first of its kind exclusively for barn doors attaches on both ends of the track for smooth travel and effortless open and close functionality.



Matte Black Finish

Model	Supported Door Weight
BDF960-1020-MB	10-20 kg (22-44 lb)
BDF960-2040-MB	20-40 kg (44-88 lb)
BDF960-4060-MB	40-60 kg (88-132 lb)
BDF960-6085-MB	60-80 kg (132-187 lb)

Features & Benefits

- The low-profile Easy Clip Soft Close is concealed behind the track and does not affect the look of your hardware
- Kit includes 2 Easy Clip Soft Close attachments for both ends of your track to open and close quietly and effortlessly
- Installs in minutes to most flat track barn door kits. Mounts directly to your previously installed hardware

Barn Door Accessories

ACME's barn door hardware assortment has various distinct handle options to add a subtle or dramatic effect to your door.

Barn Door Handle with Flush Pull



BD414-MB

BD414-SN

Privacy Locks



Matte Black
BD250-MB

Stainless Steel
BD250-SS

Accent Handles



Matte Black
BD450-MB

Stainless Steel
BD450-SS

Bronze
BD450-BR

Accent Handles



BD410-MB

BD411-MB

BD412-MB

BD413-MB

BD413-SN

2102195-HB

2102194-HB

2102200-BL

2102192

2102193-BN

Flush Pulls



6 1/2" (165 mm)

6 1/2" (165 mm)

6 1/2" (165 mm)

Matte Black
BD460-MB
BD460-BM/SS/BR

Stainless Steel
BD460-SS

Bronze
BD460-BR

Matte Black
2102198-BL

Brushed Nickel
2102198-BN

Satin Black
2102197-BL

Brushed Nickel
2102197-BN



**CLOSET DOORS
& ROOM DIVIDER
SYSTEMS**

Closet Doors

Steel Frame | Slimline Top Roll Bypass Panel Door

Acme's sliding bypass doors are the perfect closet doors for any room. Smoothly rolling from side to side, they give you access to all the space in our closet. Unlike a hinged door, they do not require space within your room to operate. The sleek look of sliding bypass doors conceals clothing and keeps storage out of sight.



Pre-finished White Smooth, Flush Panel

BRIGHT WHITE

48" x 80" - BY0100BWWTC048080
 60" x 80" - BY0100BWWTC060080
 72" x 80" - BY0100BWWTC072080



Pre-finished White Textured, Molded 6-Panel

BRIGHT WHITE

48" x 80" - BY0106BWWTC048080
 60" x 80" - BY0106BWWTC060080
 72" x 80" - BY0106BWWTC072080



Pre-finished White Smooth, Molded 2-Panel

BRIGHT WHITE

48" x 80" - BY0108BWWPC048080
 60" x 80" - BY0108BWWPC060080
 72" x 80" - BY0108BWWPC072080



Pre-finished White Smooth, Molded 2-Panel Arch

BRIGHT WHITE

48" x 80" - BY0109BWWPC048080
 60" x 80" - BY0109BWWPC060080
 72" x 80" - BY0109BWWPC072080



Pre-finished White Smooth Raised, Molded 5-Panel

BRIGHT WHITE

48" x 80" - BY0110BWWPC048080
 60" x 80" - BY0110BWWPC060080
 72" x 80" - BY0110BWWPC072080

BY0106/BY0108/BY0109/BY0110 - Additional Sizes Available

- 48" x 96"
- 60" x 96"
- 72" x 96"

BY0100 - Additional Sizes Available

- 84" x 80-1/2"
- 96" x 80-1/2"
- 108" x 80-1/2"
- 120" x 80-1/2"
- 144" x 80-1/2"
- 192" x 80-1/2"
- 48" x 96"
- 60" x 96"
- 72" x 96"
- 84" x 96"
- 96" x 96"
- 108" x 96"
- 120" x 96"
- 144" x 96"
- 192" x 96"

▪ Not available in Custom Sizes

Closet Doors

Steel Frame | Slimline Top Roll Bypass Panel Door

Acme's sliding bypass doors are the perfect closet doors for any room. Smoothly rolling from side to side, they give you access to all the space in our closet. Unlike a hinged door, they do not require space within your room to operate. The sleek look of sliding bypass doors conceals clothing and keeps storage out of sight.



Pre-finished White Smooth, Recessed 5-Panel

BRIGHT WHITE

48" x 80" - 04880MB52
60" x 80" - 06080MB52
72" x 80" - 07280MB52



Pre-finished White Smooth, Recessed 1-Panel

BRIGHT WHITE

48" x 80" - 04880MB12
60" x 80" - 06080MB12
72" x 80" - 07280MB12



Pre-finished White Chevron Molded Panel

BRIGHT WHITE

48" x 80" - BY0226BWAWM048080
60" x 80" - BY0226BWAWM060080
72" x 80" - BY0226BWAWM072080



Pre-finished Black Chevron Molded Panel

BLACK

48" x 80" - BY0226MBACM048080
60" x 80" - BY0226MBACM060080
72" x 80" - BY0226MBACM072080



Pre-finished Arctic Silver Chevron Molded Panel

ARCTIC SILVER

48" x 80" - BY0226ASAGM048080
60" x 80" - BY0226ASAGM060080
72" x 80" - BY0226ASAGM072080

Features & Benefits

- Easy-Hang hardware allow doors to lift and hook onto the top roll track system for fast installation
- Easy to maintain, light-weight pre-finished flat white panel boards
- Adjustable Easy-Hang hardware correct out-of-square door openings (+/- 1/4") improving installation appearance and operation
- Top roll sliding system with Quick-Click
- Anti-Jump Connector that ensures doors do not disengage from the track.
- Low profile
- Invisi-Track provides a hazard-free opening that allows for easy cleaning and smooth traveling doors
- Not available in Custom Sizes

Closet Doors

Steel Frame | Slimline Top Roll Bypass Panel Door

Acme's sliding bypass doors are the perfect closet doors for any room. Smoothly rolling from side to side, they give you access to all the space in our closet. Unlike a hinged door, they do not require space within your room to operate. The sleek look of sliding bypass doors conceals clothing and keeps storage out of sight.



Pre-finished White Smooth, Recessed 2-Panel

BRIGHT WHITE

48" x 80" - BY0119BWWTM048080
 60" x 80" - BY0119BWWTM060080
 72" x 80" - BY0119BWWTM072080



Pre-finished White Smooth, Recessed Mission 3-Panel

BRIGHT WHITE

48" x 80" - BY0114BWWTM048080
 60" x 80" - BY0114BWWTM060080
 72" x 80" - BY0114BWWTM072080



Pre-finished White Smooth, Recessed 3-Panel

BRIGHT WHITE

48" x 80" - BY0117BWWTM048080
 60" x 80" - BY0117BWWTM060080
 72" x 80" - BY0117BWWTM072080



Pre-finished White Smooth, Recessed 5-Panel

BRIGHT WHITE

48" x 80" - BY0112BWWTM048080
 60" x 80" - BY0112BWWTM060080
 72" x 80" - BY0112BWWTM072080



Pre-finished White Smooth, Recessed 10-Panel

BRIGHT WHITE

48" x 80" - BY0113BWWTM048080
 60" x 80" - BY0113BWWTM060080
 72" x 80" - BY0113BWWTM072080

Features & Benefits

- Easy-Hang hardware allow doors to lift and hook onto the top roll track system for fast installation
- Easy to maintain, light-weight pre-finished flat white panel boards
- Adjustable Easy-Hang hardware correct out-of-square door openings (+/- 1/4") improving installation appearance and operation
- Top roll sliding system with Quick-Click
- Anti-Jump Connector that ensures doors do not disengage from the track.
- Low profile
- Invisi-Track provides a hazard-free opening that allows for easy cleaning and smooth traveling doors
- Not available in Custom Sizes

Closet Doors

Steel Frame | Slimline Top Roll Bypass Mirror Door

Acme's sliding bypass doors are the perfect closet doors for any room. Smoothly rolling from side to side, they give you access to all the space in our closet. Unlike a hinged door, they do not require space within your room to operate. The sleek look of sliding bypass doors conceals clothing and keeps storage out of sight.



Framed Bypass - Slimline Top Roll

ARCTIC SILVER

36" x 80" - BY0120ASCLC036080
48" x 80" - BY0120ASCLC048080
60" x 80" - BY0120ASCLC060080
72" x 80" - BY0120ASCLC072080



White Slimline Frame - Slimline Top Roll

BRIGHT WHITE

36" x 80" - BY0120BWCLC036080
48" x 80" - BY0120BWCLC048080
60" x 80" - BY0120BWCLC060080
72" x 80" - BY0120BWCLC072080



Satin Gold Slimline Frame - Slimline Top Roll

SATIN GOLD

36" x 80" - BY0120SGCLC036080
48" x 80" - BY0120SGCLC048080
60" x 80" - BY0120SGCLC060080
72" x 80" - BY0120SGCLC072080

Features & Benefits

- Easy-Hang hardware allow doors to lift and hook onto the top roll track system for fast installation
- Adjustable Easy-Hang hardware correct out-of-square door openings (+/- 1/4") improving installation appearance and operation
- Top roll sliding system with Quick-Click
- Anti-Jump Connector that ensures doors do not disengage from the track.
- Low profile
- Invisi-Track provides a hazard-free opening that allows for easy cleaning and smooth traveling doors
- Custom Sizes Available

Closet Doors

Steel Frame | Slimline Bottom Roll Bypass Mirror Door

Acme's sliding bypass doors are the perfect closet doors for any room. Smoothly rolling from side to side, they give you access to all the space in our closet. Unlike a hinged door, they do not require space within your room to operate. The sleek look of sliding bypass doors conceals clothing and keeps storage out of sight.



Framed Bypass - Slimline Bottom Roll

Framed Bypass - Slimline Bottom Roll

Framed Bypass - Slimline Bottom Roll

Framed Bypass - Slimline Bottom Roll

ARCTIC SILVER

BRIGHT WHITE

SATIN GOLD

MATTE BLACK

- 48" x 80" - BY0220ASCLC048080
- 60" x 80" - BY0220ASCLC060080
- 72" x 80" - BY0220ASCLC072080
- 84" x 80" - BY0220ASCLC084080
- 84" x 80" - BY0220ASCLC096080
- 108" x 80" - BY0220ASCLC0108080
- 120" x 80" - BY0220ASCLC0120080
- 144" x 80" - BY0220ASCLC0144080
- 192" x 80" - BY0220ASCLC0192080
- 48" x 96" - BY0220ASCLC048096
- 60" x 96" - BY0220ASCLC060096
- 72" x 96" - BY0220ASCLC072096
- 84" x 96" - BY0220ASCLC084096
- 84" x 96" - BY0220ASCLC096096
- 108" x 96" - BY0220ASCLC0108096
- 120" x 96" - BY0220ASCLC0120096
- 144" x 96" - BY0220ASCLC0144096
- 192" x 96" - BY0220ASCLC0192096

- 48" x 80" - BY0220BWCLC048080
- 60" x 80" - BY0220BWCLC060080
- 72" x 80" - BY0220BWCLC072080
- 84" x 80" - BY0220BWCLC084080
- 84" x 80" - BY0220BWCLC096080
- 108" x 80" - BY0220BWCLC0108080
- 120" x 80" - BY0220BWCLC0120080
- 144" x 80" - BY0220BWCLC0144080
- 192" x 80" - BY0220BWCLC0192080
- 48" x 96" - BY0220BWCLC048096
- 60" x 96" - BY0220BWCLC060096
- 72" x 96" - BY0220BWCLC072096
- 84" x 96" - BY0220BWCLC084096
- 84" x 96" - BY0220BWCLC096096
- 108" x 96" - BY0220BWCLC0108096
- 120" x 96" - BY0220BWCLC0120096
- 144" x 96" - BY0220BWCLC0144096
- 192" x 96" - BY0220BWCLC0192096

- 48" x 80" - BY0220SGCLC048080
- 60" x 80" - BY0220SGCLC060080
- 72" x 80" - BY0220SGCLC072080
- 84" x 80" - BY0220SGCLC084080
- 84" x 80" - BY0220SGCLC096080
- 108" x 80" - BY0220SGCLC0108080
- 120" x 80" - BY0220SGCLC0120080
- 144" x 80" - BY0220SGCLC0144080
- 192" x 80" - BY0220SGCLC0192080
- 48" x 96" - BY0220SGCLC048096
- 60" x 96" - BY0220SGCLC060096
- 72" x 96" - BY0220SGCLC072096
- 84" x 96" - BY0220SGCLC084096
- 84" x 96" - BY0220SGCLC096096
- 108" x 96" - BY0220SGCLC0108096
- 120" x 96" - BY0220SGCLC0120096
- 144" x 96" - BY0220SGCLC0144096
- 192" x 96" - BY0220SGCLC0192096

- 48" x 80" - BY0220MBCLC048080
- 60" x 80" - BY0220MBCLC060080
- 72" x 80" - BY0220MBCLC072080

Features & Benefits

- Easy-Glide hardware allow doors to travel effortlessly
- Adjustable hardware correct out-of-square door openings (+/- 1/4") improving installation appearance and operation
- Bottom rolled sliding system with Quick-Click Anti-Jump Connector that ensures doors do not disengage from the track.
- Low profile
- Invisi-Track provides a hazard-free opening that allows for easy cleaning and smooth traveling doors
- Custom Sizes Available

Closet Doors

Steel Frame | Contemporary Bottom Roll Bypass Mirror Door

Acme's sliding bypass doors are the perfect closet doors for any room. Smoothly rolling from side to side, they give you access to all the space in our closet. Unlike a hinged door, they do not require space within your room to operate. The sleek look of sliding bypass doors conceals clothing and keeps storage out of sight.



Framed Bypass - Wide Curve Bottom Roll

ARCTIC SILVER

48" x 80" - BY0230ASCLC048080
 60" x 80" - BY0230ASCLC060080
 72" x 80" - BY0230ASCLC072080
 84" x 80" - BY0230ASCLC084080
 96" x 80" - BY0230ASCLC096080
 108" x 80" - BY0230ASCLC0108080
 120" x 80" - BY0230ASCLC0120080
 144" x 80" - BY0230ASCLC0144080
 192" x 80" - BY0230ASCLC0192080
 48" x 96" - BY0230ASCLC048096
 60" x 96" - BY0230ASCLC060096
 72" x 96" - BY0230ASCLC072096
 84" x 96" - BY0230ASCLC084096
 96" x 96" - BY0230ASCLC096096
 108" x 96" - BY0230ASCLC0108096
 120" x 96" - BY0230ASCLC0120096
 144" x 96" - BY0230ASCLC0144096
 192" x 96" - BY0230ASCLC0192096



Framed Bypass - Wide Curve Bottom Roll

BRIGHT WHITE

48" x 80" - BY0230BWCLC048080
 60" x 80" - BY0230BWCLC060080
 72" x 80" - BY0230BWCLC072080
 84" x 80" - BY0230BWCLC084080
 96" x 80" - BY0230BWCLC096080
 108" x 80" - BY0230BWCLC0108080
 120" x 80" - BY0230BWCLC0120080
 144" x 80" - BY0230BWCLC0144080
 192" x 80" - BY0230BWCLC0192080
 48" x 96" - BY0230BWCLC048096
 60" x 96" - BY0230BWCLC060096
 72" x 96" - BY0230BWCLC072096
 84" x 96" - BY0230BWCLC084096
 96" x 96" - BY0230BWCLC096096
 108" x 96" - BY0230BWCLC0108096
 120" x 96" - BY0230BWCLC0120096
 144" x 96" - BY0230BWCLC0144096
 192" x 96" - BY0230BWCLC0192096



Framed Bypass - Wide Curve Bottom Roll

SATIN NICKEL

48" x 80" - BY0230SNCLC048080
 60" x 80" - BY0230SNCLC060080
 72" x 80" - BY0230SNCLC072080
 84" x 80" - BY0230SNCLC084080
 96" x 80" - BY0230SNCLC096080
 48" x 96" - BY0230SNCLC048096
 60" x 96" - BY0230SNCLC060096
 72" x 96" - BY0230SNCLC072096
 84" x 96" - BY0230SNCLC084096
 96" x 96" - BY0230SNCLC096096

Features & Benefits

- Wide Curve frame with integrated handle
- Adjustable hardware correct out-of square door openings (+/- 1/4") improving installation appearance and operation
- Bottom rolled sliding system with Quick-Click Anti-Jump Connector that ensures doors do not disengage from the track.
- Low profile
- Invisi-Track provides a hazard-free opening that allows for easy cleaning and smooth traveling doors
- Custom Sizes Available

Closet Doors

Frameless | Bevelled Edge Bottom Roll Bypass Mirror Door

Acme's sliding bypass doors are the perfect closet doors for any room. Smoothly rolling from side to side, they give you access to all the space in our closet. Unlike a hinged door, they do not require space within your room to operate. The sleek look of sliding bypass doors conceals clothing and keeps storage out of sight.



Frameless Beveled Bypass Bottom Roll

BRIGHT WHITE

48" x 80" - BY320BBWCLC048080
60" x 80" - BY320BBWCLC060080
72" x 80" - BY320BBWCLC072080
84" x 80" - BY320BBWCLC084080
96" x 80" - BY320BBWCLC096080
108" x 80" - BY320BBWCLC108080
120" x 80" - BY320BBWCLC120080
144" x 80" - BY320BBWCLC0144080
192" x 80" - BY320BBWCLC0192080
48" x 96" - BY320BBWCLC048096
60" x 96" - BY320BBWCLC060096
72" x 96" - BY320BBWCLC072096
84" x 96" - BY320BBWCLC084096
96" x 96" - BY320BBWCLC096096
108" x 96" - BY320BBWCLC0108096
120" x 96" - BY320BBWCLC0120096
144" x 96" - BY320BBWCLC0144096
192" x 96" - BY320BBWCLC0192096



Frameless Beveled Bypass Bottom Roll

SATIN GOLD

48" x 80" - BY320BSGCLC048080
60" x 80" - BY320BSGCLC060080
72" x 80" - BY320BSGCLC072080
84" x 80" - BY320BSGCLC084080
96" x 80" - BY320BSGCLC096080
108" x 80" - BY320BSGCLC0108080
120" x 80" - BY320BSGCLC0120080
144" x 80" - BY320BSGCLC0144080
192" x 80" - BY320BSGCLC0192080
48" x 96" - BY320BSGCLC048096
60" x 96" - BY320BSGCLC060096
72" x 96" - BY320BSGCLC072096
84" x 96" - BY320BSGCLC084096
96" x 96" - BY320BSGCLC096096
108" x 96" - BY320BSGCLC0108096
120" x 96" - BY320BSGCLC0120096
144" x 96" - BY320BSGCLC0144096
192" x 96" - BY320BSGCLC0192096

Features & Benefits

- Edgeguard frameless frame
- Adjustable hardware correct out-of-square door openings (+/- 1/4") improving installation appearance and operation
- Bottom rolled sliding system with Quick-Click Anti-Jump Connector that ensures doors do not disengage from the track.
- Low profile
- Invisi-Track provides a hazard-free opening that allows for easy cleaning and smooth traveling doors
- Custom Sizes Available

Closet Doors

Frameless | Polished Edge Bottom Roll Bypass Mirror Door

Acme's sliding bypass doors are the perfect closet doors for any room. Smoothly rolling from side to side, they give you access to all the space in our closet. Unlike a hinged door, they do not require space within your room to operate. The sleek look of sliding bypass doors conceals clothing and keeps storage out of sight.



Frameless Polished Bypass Bottom Roll

BRIGHT WHITE

48" x 80" - BY320PBWCLC048080
 60" x 80" - BY320PBWCLC060080
 72" x 80" - BY320PBWCLC072080
 84" x 80" - BY320PBWCLC084080
 96" x 80" - BY320PBWCLC096080
 108" x 80" - BY320PBWCLC108080
 120" x 80" - BY320PBWCLC120080
 144" x 80" - BY320PBWCLC0144080
 192" x 80" - BY320PBWCLC0192080
 48" x 96" - BY320PBWCLC048096
 60" x 96" - BY320PBWCLC060096
 72" x 96" - BY320PBWCLC072096
 84" x 96" - BY320PBWCLC084096
 96" x 96" - BY320PBWCLC096096
 108" x 96" - BY320PBWCLC0108096
 120" x 96" - BY320PBWCLC0120096
 144" x 96" - BY320PBWCLC0144096
 192" x 96" - BY320PBWCLC0192096



Frameless Polished Bypass Bottom Roll

SATIN GOLD

48" x 80" - BY320PASCLC048080
 60" x 80" - BY320PASCLC060080
 72" x 80" - BY320PASCLC072080
 84" x 80" - BY320PASCLC084080
 96" x 80" - BY320PASCLC096080
 108" x 80" - BY320PASCLC0108080
 120" x 80" - BY320PASCLC0120080
 144" x 80" - BY320PASCLC0144080
 192" x 80" - BY320PASCLC0192080
 48" x 96" - BY320PASCLC048096
 60" x 96" - BY320PASCLC060096
 72" x 96" - BY320PASCLC072096
 84" x 96" - BY320PASCLC084096
 96" x 96" - BY320PASCLC096096
 108" x 96" - BY320PASCLC0108096
 120" x 96" - BY320PASCLC0120096
 144" x 96" - BY320PASCLC0144096
 192" x 96" - BY320PASCLC0192096

Features & Benefits

- Edgeguard frameless frame
- Adjustable hardware correct out-of-square door openings (+/- 1/4") improving installation appearance and operation
- Bottom rolled sliding system with Quick-Click Anti-Jump Connector that ensures doors do not disengage from the track.
- Low profile
- Invisi-Track provides a hazard-free opening that allows for easy cleaning and smooth traveling doors
- Custom Sizes Available

Closet Doors

Aluminum Frame | Slimline Bottom Roll Bypass Mirror Door

Acme's aluminum framed sliding bypass doors are the perfect closet doors for any room. Aluminum is lightweight and extremely smooth rolling from side to side while giving you access to all the space in our closet. Unlike a hinged door, they do not require space within your room to operate. The sleek look of sliding bypass doors conceals clothing and keeps storage out of sight.



Aluminum Framed - Slimline Top Roll

SATIN CHROME

48" x 80" - BY0250W1CLC048080
 60" x 80" - BY0250W1CLC060080
 72" x 80" - BY0250W1CLC072080
 84" x 80" - BY0250W1CLC084080
 96" x 80" - BY0250W1CLC096080
 108" x 80" - BY0250W1CLC0108080
 120" x 80" - BY0250W1CLC0120080
 144" x 80" - BY0250W1CLC0144080
 192" x 80" - BY0250W1CLC0192080
 48" x 96" - BY0250W1CLC048096
 60" x 96" - BY0250W1CLC060096
 72" x 96" - BY0250W1CLC072096
 84" x 96" - BY0250W1CLC084096
 96" x 96" - BY0250W1CLC096096
 108" x 96" - BY0250W1CLC0108096
 120" x 96" - BY0250W1CLC0120096
 144" x 96" - BY0250W1CLC0144096
 192" x 96" - BY0250W1CLC0192096



Aluminum Framed - Slimline Top Roll

BRIGHT CHROME

48" x 80" - BY0250W1CLC048080
 60" x 80" - BY0250W1CLC060080
 72" x 80" - BY0250W1CLC072080
 84" x 80" - BY0250W1CLC084080
 96" x 80" - BY0250W1CLC096080
 108" x 80" - BY0250W1CLC0108080
 120" x 80" - BY0250W1CLC0120080
 144" x 80" - BY0250W1CLC0144080
 192" x 80" - BY0250W1CLC0192080
 48" x 96" - BY0250W1CLC048096
 60" x 96" - BY0250W1CLC060096
 72" x 96" - BY0250W1CLC072096
 84" x 96" - BY0250W1CLC084096
 96" x 96" - BY0250W1CLC096096
 108" x 96" - BY0250W1CLC0108096
 120" x 96" - BY0250W1CLC0120096
 144" x 96" - BY0250W1CLC0144096
 192" x 96" - BY0250W1CLC0192096



Aluminum Framed - Slimline Top Roll

BRIGHT WHITE

48" x 80" - BY0250W1CLC048080
 60" x 80" - BY0250W1CLC060080
 72" x 80" - BY0250W1CLC072080
 84" x 80" - BY0250W1CLC084080
 96" x 80" - BY0250W1CLC096080
 108" x 80" - BY0250W1CLC0108080
 120" x 80" - BY0250W1CLC0120080
 144" x 80" - BY0250W1CLC0144080
 192" x 80" - BY0250W1CLC0192080
 48" x 96" - BY0250W1CLC048096
 60" x 96" - BY0250W1CLC060096
 72" x 96" - BY0250W1CLC072096
 84" x 96" - BY0250W1CLC084096
 96" x 96" - BY0250W1CLC096096
 108" x 96" - BY0250W1CLC0108096
 120" x 96" - BY0250W1CLC0120096
 144" x 96" - BY0250W1CLC0144096
 192" x 96" - BY0250W1CLC0192096

Features & Benefits

- Edgeguard frameless frame
- Adjustable hardware correct out-of-square door openings (+/- 1/4") improving installation appearance and operation
- Bottom rolled sliding system with Quick-Click Anti-Jump Connector that ensures doors do not disengage from the track.
- Low profile
- Invisi-Track provides a hazard-free opening that allows for easy cleaning and smooth traveling doors
- Custom Sizes Available

Closet Doors

Steel Frame | Slimline Bifold Door

Acme steel bifold doors operate as rolling pivot system featuring Easy-Roll bifold hardware and low-profile top and bottom track.



Pre-finished White Smooth, Flush Panel

BRIGHT WHITE

- 24" x 80" - B10221BW10E024080
- 30" x 80" - B10221BW10E030080
- 36" x 80" - B10221BW10E036080
- 48" x 80" - B10221BW10E048080
- 60" x 80" - B10221BW10E060080
- 72" x 80" - B10221BW10E072080



Pre-finished White Textured, Molded 6-Panel

BRIGHT WHITE

- 24" x 80" - B10221BW16E024080
- 30" x 80" - B10221BW16E030080
- 36" x 80" - B10221BW16E036080
- 48" x 80" - B10221BW16E048080
- 60" x 80" - B10221BW16E060080
- 72" x 80" - B10221BW16E072080



Pre-finished White Smooth, Molded 2-Panel

BRIGHT WHITE

- 24" x 80" - B10221BW18E024080
- 30" x 80" - B10221BW18E030080
- 36" x 80" - B10221BW18E036080
- 48" x 80" - B10221BW18E048080
- 60" x 80" - B10221BW18E060080
- 72" x 80" - B10221BW18E072080



Frameless Bifold - Slimline Mirror

BRIGHT WHITE

- 24" x 80" - B10221BWCLC024080
- 30" x 80" - B10221BWCLC030080
- 36" x 80" - B10221BWCLC036080
- 48" x 80" - B10221BWCLC048080
- 60" x 80" - B10221BWCLC060080
- 72" x 80" - B10221BWCLC072080

- **B10221BW10** - Custom Sizes Available
- **B10221BW16** - Standard Sizes Only
- **B10221BW18** - Custom Sizes Available
- **B10221BWCL** - Custom Sizes Available

Closet Doors

Frameless | Bevelled Edge Bifold Mirror Door

Acme steel bifold doors operate as rolling pivot system featuring Easy-Roll bifold hardware and low-profile top and bottom track.



Frameless Bifold, Beveled Edge Mirror

ARCTIC SILVER

24" x 80" - BI321BASCLC024080
30" x 80" - BI321BASCLC030080
36" x 80" - BI321BASCLC036080
48" x 80" - BI321BASCLC048080
60" x 80" - BI321BASCLC060080
72" x 80" - BI321BASCLC072080
24" x 96" - BI321BASCLC024096
30" x 96" - BI321BASCLC030096
36" x 96" - BI321BASCLC036096
48" x 96" - BI321BASCLC048096
60" x 96" - BI321BASCLC060096
72" x 96" - BI321BASCLC072096



Frameless Bifold, Beveled Edge Mirror

BRIGHT WHITE

24" x 80" - BI321BBWCLC024080
30" x 80" - BI321BBWCLC030080
36" x 80" - BI321BBWCLC036080
48" x 80" - BI321BBWCLC048080
60" x 80" - BI321BBWCLC060080
72" x 80" - BI321BBWCLC072080
24" x 96" - BI321BBWCLC024096
30" x 96" - BI321BBWCLC030096
36" x 96" - BI321BBWCLC036096
48" x 96" - BI321BBWCLC048096
60" x 96" - BI321BBWCLC060096
72" x 96" - BI321BBWCLC072096

Features & Benefits

- Offset pivot action creates an additional 4" for more complete access to your closet or space
- Increased adjustability for out-of-square door openings improves door appearance and operation
- Easy-Roll connector results in less friction on the track for smoother travel
- Low profile, direct floor-mounted and pre-drilled bottom track for quick installation—Makes cleaning a breeze
- A metal pull attached to the inside frame stile between panels is used to operate the door
- Custom Sizes Available

Closet Doors

Frameless | Polished Edge Bifold Mirror Door

Acme steel bifold doors operate as rolling pivot system featuring Easy-Roll bifold hardware and low-profile top and bottom track.



Frameless Bifold, Polished Edge Mirror

ARCTIC SILVER

24" × 80" - BI321PASCLC024080
30" × 80" - BI321PASCLC030080
36" × 80" - BI321PASCLC036080
48" × 80" - BI321PASCLC048080
60" × 80" - BI321PASCLC060080
72" × 80" - BI321PASCLC072080
24" × 96" - BI321PASCLC024096
30" × 96" - BI321PASCLC030096
36" × 96" - BI321PASCLC036096
48" × 96" - BI321PASCLC048096
60" × 96" - BI321PASCLC060096
72" × 96" - BI321PASCLC072096



Frameless Bifold, Polished Edge Mirror

BRIGHT WHITE

24" × 80" - BI321PBWCLC024080
30" × 80" - BI321PBWCLC030080
36" × 80" - BI321PBWCLC036080
48" × 80" - BI321PBWCLC048080
60" × 80" - BI321PBWCLC060080
72" × 80" - BI321PBWCLC072080
24" × 96" - BI321PBWCLC024096
30" × 96" - BI321PBWCLC030096
36" × 96" - BI321PBWCLC036096
48" × 96" - BI321PBWCLC048096
60" × 96" - BI321PBWCLC060096
72" × 96" - BI321PBWCLC072096

Features & Benefits

- Offset pivot action creates an additional 4" for more complete access to your closet or space
- Increased adjustability for out-of-square door openings improves door appearance and operation
- Easy-Roll connector results in less friction on the track for smoother travel
- Low profile, direct floor-mounted and pre-drilled bottom track for quick installation—Makes cleaning a breeze
- A metal pull attached to the inside frame stile between panels is used to operate the door
- Customer Sizes Available

Closet Doors

1-Lite | Pre-finished Engineered Wood Bypass Door

ACME's sliding bypass doors are the perfect closet doors for any room. Smoothly rolling from side to side, they give you access to all the space in our closet. Unlike a hinged door, they do not require space within your room to operate. The sleek look of sliding bypass doors conceals clothing and keeps storage out of sight.

Features & Benefits

- Available in both standard closet opening sizes and custom sizes
- Easy-Hang hardware allow doors to lift and hook onto the top roll track system for fast installation
- Easy to maintain, pre-finished decor wrapped 2 1/2" frame
- Adjustable hardware to correct out-of-square door openings (+/- 1/4") improving installation appearance and operation
- Available in opaque frosted glass or distortion free clear mirror
- No bottom track provides a hazard-free opening that allows for easy cleaning and does not damage floors
- Custom sizes available

Standard Sizes: (W) 48", 60", 72" x (H) 80 1/12" , 96"

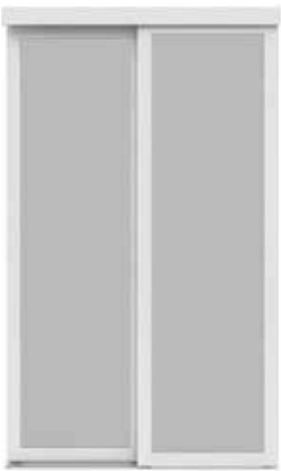

1-LITE in Smooth White

Opaque Glass | C0425
Clear Mirror | C0125

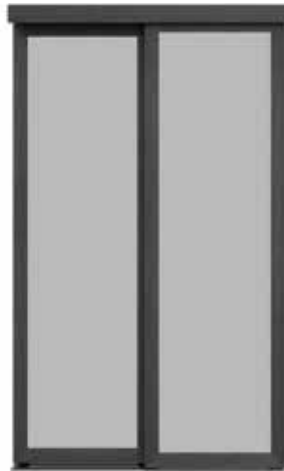

1-LITE in Woodgrain Black

Opaque Glass | C0460
Clear Mirror | C0160



1-LITE in Antique

Opaque Glass | C0459
Clear Mirror | C0159

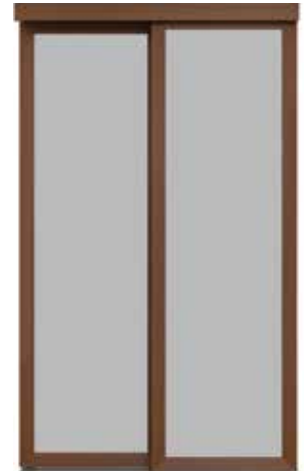

1-LITE in Gunstock

Opaque Glass | C0433
Clear Mirror | C0133



1-LITE in Chocolate

Opaque Glass | C0416
Clear Mirror | C0116

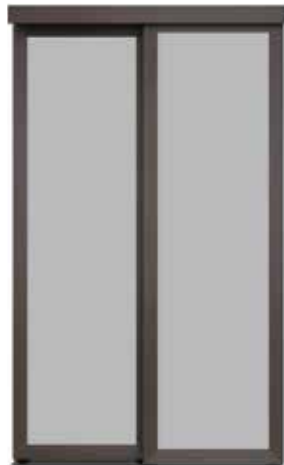

1-LITE in Mocha

Opaque Glass | C04781
Clear Mirror | C01781

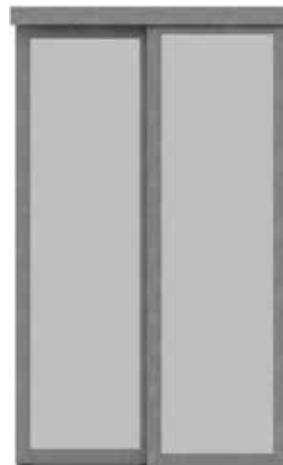

1-LITE in Steel Grey

Opaque Glass - C0455
Clear Glass - C0155



CLEAR MIRROR INSERT



OPAQUE GLASS INSERT

Closet Doors

1-LITE | Pre-finished Engineered Wood Bypass Door with Handle

ACME's sliding bypass doors are the perfect closet doors for any room. Smoothly rolling from side to side, they give you access to all the space in our closet. Unlike a hinged door, they do not require space within your room to operate. The sleek look of sliding bypass doors conceals clothing and keeps storage out of sight.

Features & Benefits

- Available in both standard closet opening sizes and custom sizes
- Stainless Steel tubular handle creates easier access to closet and a contemporary accent in your room
- Easy-Hang hardware allow doors to lift and hook onto the top roll track system for fast installation
- Easy to maintain, pre-finished decor wrapped 2 1/2" frame
- Adjustable hardware to correct out-of-square door openings (+/- 1/4") improving installation appearance and operation
- Available in opaque frosted glass or distortion free clear mirror
- No bottom track provides a hazard-free opening that allows for easy cleaning and does not damage floors
- Custom sizes available

Standard Sizes: (W) 48", 60", 72" x (H) 80 1/12" , 96"

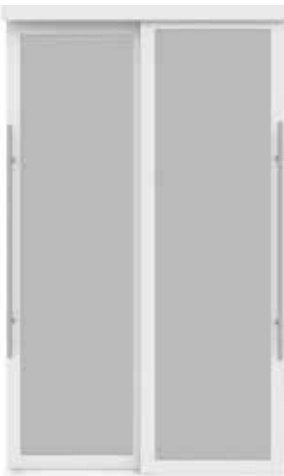

LOUNGE in Bright White

Opaque Glass | C0425L
Clear Mirror | C0125L

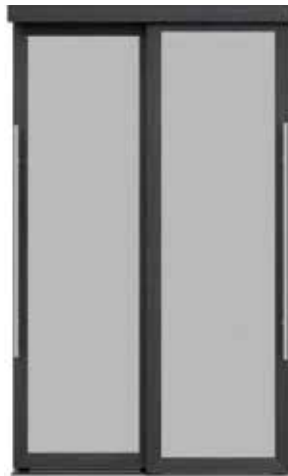

LOUNGE in Woodgrain Black

Opaque Glass | C0460L
Clear Mirror | C0160L



LOUNGE in Antique

Opaque Glass | C0459L
Clear Mirror | C0159L



LOUNGE in Gunstock

Opaque Glass | C0433L
Clear Mirror | C0133L



LOUNGE in Chocolate

Opaque Glass | C0416L
Clear Mirror | C0116L

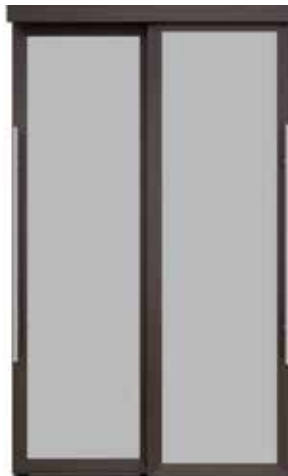

LOUNGE in Mocha

Opaque Glass | C04781L
Clear Mirror | C01781L

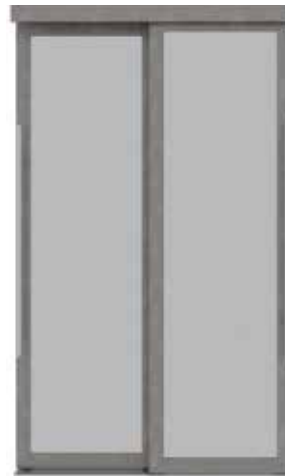

LOUNGE in Steel Grey

Opaque Glass - C0455L
Clear Glass - C0155L



CLEAR MIRROR INSERT



OPAQUE GLASS INSERT

Closet Doors

3-LITE | Pre-finished Engineered Wood Bypass Door

ACME's sliding bypass doors are the perfect closet doors for any room. Smoothly rolling from side to side, they give you access to all the space in our closet. Unlike a hinged door, they do not require space within your room to operate. The sleek look of sliding bypass doors conceals clothing and keeps storage out of sight.

Features & Benefits

- Available in both standard closet opening sizes and custom sizes
- Easy-Hang hardware allow doors to lift and hook onto the top roll track system for fast installation
- Easy to maintain, pre-finished decorwrapped 2 1/2" frame
- Adjustable hardware to correct out-of-square door openings (+/- 1/4") improving installation appearance and operation
- Available in opaque frosted glass or distortion free clear mirror
- No bottom track provides a hazard-free opening that allows for easy cleaning and does not damage floors
- Custom sizes available

Standard Sizes: (W) 48", 60", 72" x (H) 80 1/12" , 96"

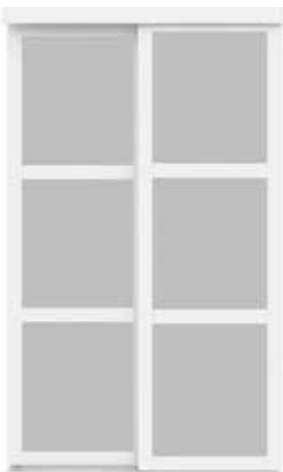

3-LITE in Bright White

Opaque Glass | C04263
Clear Mirror | C01263

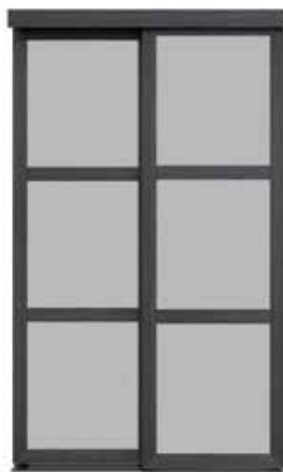

3-LITE in Woodgrain Black

Opaque Glass | C04613
Clear Mirror | C01613



3-LITE in Antique

Opaque Glass | C04823
Clear Mirror | C01823

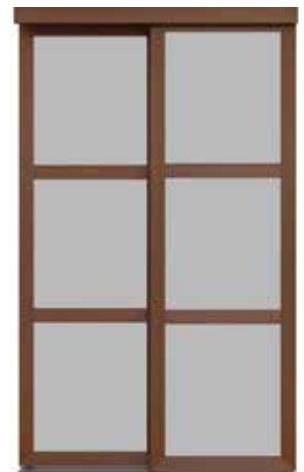

3-LITE in Gunstock

Opaque Glass | C04343
Clear Mirror | C01343



3-LITE in Chocolate

Opaque Glass | C04173
Clear Mirror | C01173



3-LITE in Mocha

Opaque Glass | C00478
Clear Mirror | C00178

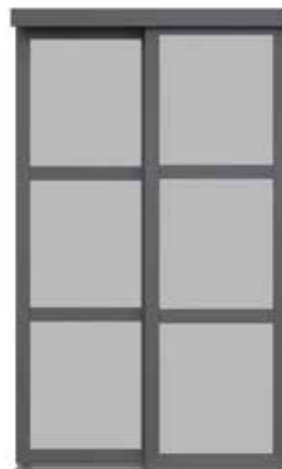

3-LITE in Steel Grey

Opaque Glass - C04563
Clear Mirror - C01563



CLEAR MIRROR INSERT



OPAQUE GLASS INSERT

Closet Doors

4-LITE | Pre-finished Engineered Wood Bypass Door

ACME's sliding bypass doors are the perfect closet doors for any room. Smoothly rolling from side to side, they give you access to all the space in our closet. Unlike a hinged door, they do not require space within your room to operate. The sleek look of sliding bypass doors conceals clothing and keeps storage out of sight.

Features & Benefits

- Available in both standard closet opening sizes and custom sizes
- Easy-Hang hardware allow doors to lift and hook onto the top roll track system for fast installation
- Easy to maintain, pre-finished decor wrapped 2 1/2" frame
- Adjustable hardware to correct out-of-square door openings (+/- 1/4") improving installation appearance and operation
- Available in opaque frosted glass or distortion free clear mirror
- No bottom track provides a hazard-free opening that allows for easy cleaning and does not damage floors
- Custom sizes available

Standard Sizes: (W) 48", 60", 72" x (H) 80 1/12" , 96"

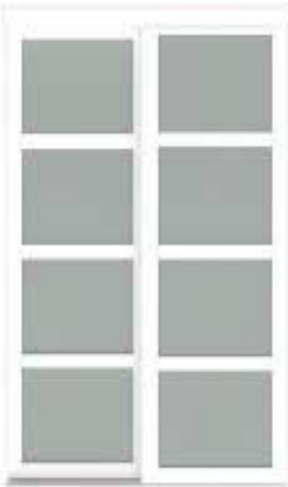

4-LITE in Bright White

Opaque Glass | C0426
Clear Mirror | C0126



4-LITE in Woodgrain Black

Opaque Glass | C0461
Clear Mirror | C0161



4-LITE in Antique

Opaque Glass | C0482
Clear Mirror | C0182



4-LITE in Gunstock

Opaque Glass | C0434
Clear Mirror | C0134

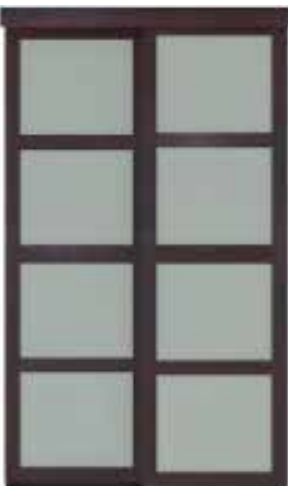

4-LITE in Chocolate

Opaque Glass | C0417
Clear Mirror | C0117



4-LITE in Mocha

Opaque Glass | C04784
Clear Mirror | C01784



4-LITE in Steel Grey

Opaque Glass | C0456
Clear Mirror | C0156



CLEAR MIRROR INSERT



OPAQUE GLASS INSERT

Closet Doors

5-LITE | Pre-finished Engineered Wood Bypass Door

ACME's sliding bypass doors are the perfect closet doors for any room. Smoothly rolling from side to side, they give you access to all the space in our closet. Unlike a hinged door, they do not require space within your room to operate. The sleek look of sliding bypass doors conceals clothing and keeps storage out of sight.

Features & Benefits

- Available in both standard closet opening sizes and custom sizes
- Easy-Hang hardware allow doors to lift and hook onto the top roll track system for fast installation
- Easy to maintain, pre-finished decor wrapped 2 1/2" frame
- Adjustable hardware to correct out-of-square door openings (+/- 1/4") improving installation appearance and operation
- Available in opaque frosted glass or distortion free clear mirror
- No bottom track provides a hazard-free opening that allows for easy cleaning and does not damage floors
- Custom sizes available

Standard Sizes: (W) 48", 60", 72" x (H) 80 1/12" , 96"



5-LITE in Bright White

Opaque Glass | C0479
Clear Mirror | C0179

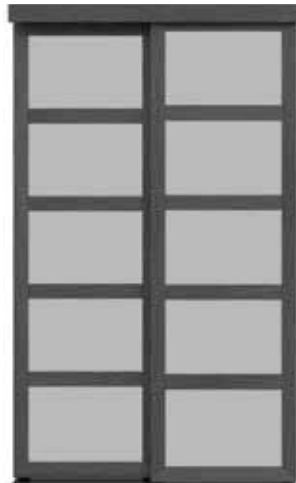

5-LITE in Woodgrain Black

Opaque Glass | C04615
Clear Mirror | C01615



5-LITE in Antique

Opaque Glass | C04825
Clear Mirror | C01825



5-LITE in Gunstock

Opaque Glass | C04345
Clear Mirror | C01345



5-LITE in Chocolate

Opaque Glass | C04175
Clear Mirror | C01175



5-LITE in Mocha

Opaque Glass | C04785
Clear Mirror | C01785



5-LITE in Steel Grey

Opaque Glass | C04565
Clear Mirror | C01565



CLEAR MIRROR INSERT



OPAQUE GLASS INSERT

Closet Doors

4-LITE | Pre-finished Engineered Wood Bypass Door

ACME's sliding bypass doors are the perfect closet doors for any room. Smoothly rolling from side to side, they give you access to all the space in our closet. Unlike a hinged door, they do not require space within your room to operate. The sleek look of sliding bypass doors conceals clothing and keeps storage out of sight.

Features & Benefits

- Available in both standard closet opening sizes and custom sizes
- Easy-Hang hardware allow doors to lift and hook onto the top roll track system for fast installation
- Easy to maintain, pre-finished decor wrapped 2 1/2" frame
- Adjustable hardware to correct out-of-square door openings (+/- 1/4") improving installation appearance and operation
- Available in opaque frosted glass or distortion free clear mirror
- No bottom track provides a hazard-free opening that allows for easy cleaning and does not damage floors
- Custom sizes available

Standard Sizes: (W) 48", 60", 72" x (H) 80 1/12" , 96"



4-LITE in Bright White
Opaque Glass | C0488



4-LITE in Antique
Opaque Glass | C0



4-LITE in Woodgrain Black
Opaque Glass | C0485



4-LITE in Steel Grey
Opaque Glass | C0454

Closet Doors

Decor Wrap Engineered Wood Framed Bypass Door

ACME's sliding bypass doors are the perfect closet doors for any room. A modern take on sliding doors with designs to match all door styles within the home. Smoothly rolling from side to side, they give you access to all the space in our closet. Unlike a hinged door, they do not require space within your room to operate. The sleek look of sliding bypass doors conceals clothing and keeps storage out of sight.

Features & Benefits

- Easy-Hang hardware allow doors to lift and hook onto the top roll track system for fast installation
- Easy to maintain, pre-finished decor wrapped 2 1/2" frame
- Adjustable hardware to correct out-of-square door openings (+/- 1/4") improving installation appearance and operation
- No bottom track provides a hazard-free opening that allows for easy cleaning and does not damage floors
- Available in standard closet opening sizes only

Standard Sizes: (W) 48", 60", 72" x (H) 80 1/12" , 96"



COUNTRYSIDE in Antique
COB59K



COUNTRYSIDE in White
COL25K



MISSION in White
COL57

Closet Doors

Pre-finished Engineered Wood Bypass & Pivot Door

Our Urban Closet Door Series provides a contemporary alternative to traditional closet doors. Inspired by the style and materials of today's interior barn doors, our Urban series doors are meticulously crafted with the combination of materials including our pre-finished, scratch-resistant engineered wood, frosted tempered glass or traditional clear mirror.

Features & Benefits

- Easy-Hang hardware allow doors to lift and hook onto the top roll track system for fast installation
- Easy to maintain, pre-finished decor wrapped 3" frame
- Adjustable hardware to correct out-of-square door openings (+/- 1/4") improving installation appearance and operation
- No bottom track provides a hazard-free opening that allows for easy cleaning and does not damage floors
- Available in standard closet opening sizes only



HARMONY 1-LITE
in Pure White | Clear Mirror

48" x 80" - EU3210PWCLE048080
60" x 80" - EU3210PWCLE060080
72" x 80" - EU3210PWCLE072080



TWILIGHT 1-LITE
in Pure White | Tempered Frosted Glass

48" x 80" - EU3220PWFGE048080
60" x 80" - EU3220PWFGE060080
72" x 80" - EU3220PWFGE072080



LACE 4-LITE X-DESIGN
in Pure White | Clear Mirror

48" x 80" - EU3265PWCLE048080
60" x 80" - EU3265PWCLE060080
72" x 80" - EU3265PWCLE072080

Closet Doors

Pre-finished Engineered Wood Bypass Door

Unlike a hinged door, they do not require space to operate. The sleek look of sliding bypass closet doors conceals clothing and keeps storage out of sight. Our wood frame & glass inserts modernize your space and add light by selecting a bypass door built with full length frosted glass. With a multitude of options you can select an insert pattern to make your design more dynamic.

Features & Benefits

- Easy-Hang hardware allow doors to lift and hook onto the top roll track system for fast installation
- Easy to maintain, pre-finished decor wrapped 4" frame
- Adjustable hardware to correct out-of-square door openings (+/- 1/4") improving installation appearance and operation
- No bottom track provides a hazard-free opening that allows for easy cleaning and does not damage floors
- Available in standard closet opening sizes only / Cannot be painted, stained or cut



1-LITE
in Bright White

48" x 80" - EU2010BWFGE048080
60" x 80" - EU2010BWFGE060080
72" x 80" - EU2010BWFGE072080



1-LITE
in Espresso

48" x 80" - EU2230ESFGE048080
60" x 80" - EU2230ESFGE060080
72" x 80" - EU2230ESFGE072080



1-LITE
in Iron Age

48" x 80" - EU2450IAFGE048080
60" x 80" - EU2450IAFGE060080
72" x 80" - EU2450IAFGE072080



5-LITE
in Espresso

48" x 80" - EU2240ESFGE048080
60" x 80" - EU2240ESFGE060080
72" x 80" - EU2240ESFGE072080



5-LITE
in Iron Age

48" x 80" - EU2470IAFGE048080
60" x 80" - EU2470IAFGE060080
72" x 80" - EU2470IAFGE072080



3-LITE
in Off-White

48" x 80" - EU2030BWFGE048080
60" x 80" - EU2030BWFGE060080
72" x 80" - EU2030BWFGE072080



3-LITE
in Espresso

48" x 80" - EU2290ESFGE048080
60" x 80" - EU2290ESFGE060080
72" x 80" - EU2290ESFGE072080



3-LITE
in Iron Age

48" x 80" - EU2460IAFGE048080
60" x 80" - EU2460IAFGE060080
72" x 80" - EU2460IAFGE072080

Closet Doors

Pre-finished Engineered Wood Bifold Door

Sleek and unobtrusive, our sliding bifold closet door systems are available with two or four panels that fold up to maximize your opening. You'll have the flexibility to present your closet in different ways, depending on how much you want to reveal, without compromising your style or the space in your closet. Bifold closet doors fold into each other to provide you up to 95% access to your closet with minimal floor clearance and taking minimal space within your room.

Features & Benefits

- Sliding mini 3-wheel connector results in less friction on the track for smoother travel, and trackless door design keeps your floor opening clear and hazard-free
- Easy to maintain, pre-finished decor wrapped 4" frame
- Includes a round closet door knob pull in Satin Nickel finish to easily open and close your doors
- No bottom track provides a hazard-free opening that allows for easy cleaning and does not damage floors
- Available in standard closet opening sizes only / Cannot be painted, stained or cut



1-LITE
in Off-White

24" x 80" - EU3010BWFGE024080
30" x 80" - EU3010BWFGE030080
36" x 80" - EU3010BWFGE036080



1-LITE
in Espresso

24" x 80" - EU3030ESFGE024080
30" x 80" - EU3030ESFGE030080
36" x 80" - EU3030ESFGE036080



1-LITE
in Iron Age

24" x 80" - EU3101AFGE024080
30" x 80" - EU3101AFGE030080
36" x 80" - EU3101AFGE036080



3-LITE
in Off-White

24" x 80" - EU3080BWFGE024080
30" x 80" - EU3080BWFGE030080
36" x 80" - EU3080BWFGE036080



3-LITE
in Espresso

24" x 80" - EU3100ESFGE024080
30" x 80" - EU3100ESFGE030080
36" x 80" - EU3100ESFGE036080



3-LITE
in Iron Age

24" x 80" - EU31501AFGE024080
30" x 80" - EU31501AFGE030080
36" x 80" - EU31501AFGE036080

Closet Doors

Pre-finished Engineered Wood Pivot Door

Need to install a door into an existing opening but want to avoid installing hinges or messing with the door jamb? Pivot closet doors swing open making them the perfect solution by providing maximum access to your closet or storage space. Select from an assortment of modern, engineered wood doors featuring tempered glass inserts. Prefinished on both sides, the easy-to-maintain, scratch-resistant pivot closet doors save you time and mess by skipping the painting and staining.

Features & Benefits

- Easy-to-install top and bottom spring-loaded pivot connectors allow the pivot closet door to swing open providing maximum access to your space, and the magnetic catch keeps the door closed
- Easy-to-maintain, solid engineered wood closet door frames are scratch-resistant and will not warp or crack as result of humidity changes in the home
- Prefinished on both sides in a textured wood look Pure White, this modern closet door and matching fascia save you time and mess by skipping the painting, staining and clean-up of unfinished doors and trim
- Each door panel's contemporary 4mm frosted tempered glass inserts allow for light transmission and is up to four times stronger than regular glass
- Includes a round closet door knob pull in Satin Nickel finish to easily open and close your doors
- Standard Sizes Only / Cannot be painted, stained or cut



**1-LITE
in Off-White**

24" x 80" - PV5401BWFGE024080
30" x 80" - PV5401BWFGE030080
36" x 80" - PV5401BWFGE036080



**1-LITE
in Espresso**

24" x 80" - PV5401ESFGE024080
30" x 80" - PV5401ESFGE030080
36" x 80" - PV5401ESFGE036080



**1-LITE
in Iron Age**

24" x 80" - PV5401IAFGE048080
30" x 80" - PV5401IAFGE060080
36" x 80" - PV5401IAFGE072080



**3-LITE
in Off-White**

24" x 80" - PV5402BWFGE024080
30" x 80" - PV5402BWFGE030080
36" x 80" - PV5402BWFGE036080



**3-LITE
in Espresso**

24" x 80" - PV5402ESFGE024080
30" x 80" - PV5402ESFGE030080
36" x 80" - PV5402ESFGE036080



**3-LITE
in Iron Age**

24" x 80" - PV5402IAFGE024080
30" x 80" - PV5402IAFGE030080
36" x 80" - PV5402IAFGE036080



**CROCHET 8X-LITE
in Graphite Gray**

48" x 80" - PV3330GGFGE048080
60" x 80" - PV3330GGFGE060080
72" x 80" - PV3330GGFGE072080



**PROVINCIAL 8-LITE
in Pure White**

48" x 80" - PV3340PWFGE048080
60" x 80" - PV3340PWFGE060080
72" x 80" - PV3340PWFGE072080

Room Divider Systems

Across-The-Wall | Extruded Aluminum Door Systems

In fashionable hospitality and commercial environments, interior designers are always on the lookout for stylish products that will enhance the decor of guest rooms while adding to the visitor experience for the busy commercial or vacation traveler. These extruded aluminum doors combine the benefits of quality, lightweight stile and rail construction with a fully glazed glass appearance to let light in or reflect light to brighten the environment.



PANELS		PANEL SIZE	
QUANTITY	WIDTH	HEIGHT	
1	36"	90"	
	42"		
	48"	110"	
	60"		

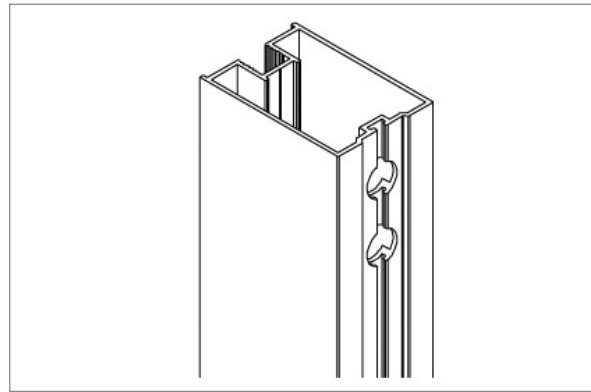

STILE PROFILE

7041 | Top Roll Sliding Door 1-Panel Passage Way Door System

Top rolled system means no bottom track making it a great option for hard surface flooring.

Frame Finishes



Satin



Black



Clear Mirror



Semi-Opaque Glass



White or Black Back Painted Glass

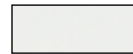

Clear Glass

Insert Finishes

Standard Sizes

- 36" x 84"
- 42" x 84"
- Custom sizes available in both width & height. Additional panels available based on opening width. Contact us for more information

Features & Benefits

- Modern 2" x 1-3/8" extruded aluminum frame is lightweight for a quiet opening and closing action
- Various frame and insert finishes and materials to match your interior decor
- Opening force meets the requirements of ADA
- Precision bearing rollers provide a smooth, quiet slide that has been tested over 100,000 open/close cycles
- North American Made

Specifications

- Clear Mirror | Double-sided 2.8mm with Safety Backing
- White/Black Back Painted Glass | Double-Sided 2.8mm with Safety Backing
- Semi-Opaque Glass | 6mm Frosted Laminated Glass
- Clear Glass | 6mm Frosted Laminated Glass

Room Divider Systems

Across-The-Wall | Extruded Aluminum Door Systems

In fashionable hospitality and commercial environments, interior designers are always on the lookout for stylish products that will enhance the decor of guest rooms while adding to the visitor experience for the busy commercial or vacation traveler. These extruded aluminum doors combine the benefits of quality, lightweight stile and rail construction with a fully glazed glass appearance to let light in or reflect light to brighten the environment.



PANELS		PANEL SIZE	
QUANTITY	WIDTH	HEIGHT	
3	108"	110"	
	120"		
	144"		
4	144"		

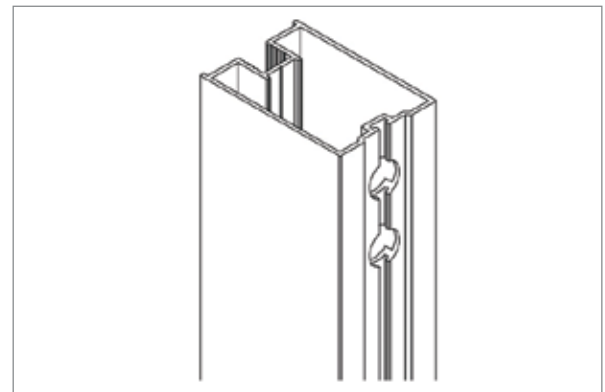

STILE PROFILE

7039 | Bottom Roll Bypass 3-Panel Room Divider

Bottom rolled system utilizes ADA compliant tracks for 2-panel or multi-panel solutions allowing wheel-chair accessibility.

Frame Finishes



Satin



Black

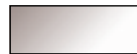

Clear
Mirror

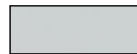

Semi-Opaque
Glass



White or Black
Back Painted
Glass

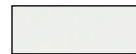

Clear Glass

Insert Finishes

Standard Sizes

- 108" x 110"
- 120" x 110"
- 144" x 110"
- Custom sizes available in both width & height. Additional panels available based on opening width. Contact us for more information

Features & Benefits

- Modern 2" x 1-3/8" extruded aluminum frame is lightweight for a quiet opening and closing action
- Various frame and insert finishes and materials to match your interior decor
- Opening force meets the requirements of ADA
- Precision bearing rollers provide a smooth, quiet slide that has been tested over 100,000 open/close cycles
- North American Made

Specifications

- Clear Mirror | Double-sided 2.8mm with Safety Backing
- White/Black Back Painted Glass | Double-Sided 2.8mm with Safety Backing
- Semi-Opaque Glass | 6mm Frosted Laminated Glass
- Clear Glass | 6mm Frosted Laminated Glass

Closet Doors

Extruded Aluminum Bypass | Bottom Roll System

In fashionable hospitality and commercial environments, interior designers are always on the lookout for stylish products that will enhance the decor of guest rooms while adding to the visitor experience for the busy commercial or vacation traveler. These extruded aluminum doors combine the benefits of quality, lightweight stile and rail construction with a fully glazed glass appearance to let light in or reflect light to brighten the environment.



PANELS		PANEL SIZE	
QUANTITY	WIDTH	HEIGHT	
2	48"	80"	
	60"		
	72"		
	84"		
	96"		
3	108"		

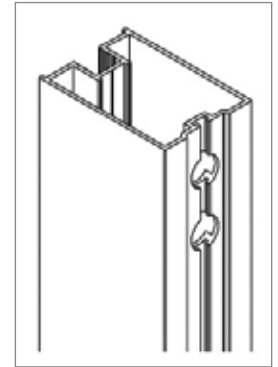

STILE PROFILE

QUANTITY	WIDTH	HEIGHT
2	48"	96"
	60"	
	72"	
	84"	
	96"	
3	108"	

7035 | Bottom Roll Bypass Room Divider / Closet Door System

Top roll system with bottom guide track provides travel stability; ideal for wider panel(s) or used in a closet opening.

Frame Finishes



Satin



Black

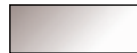

Clear Mirror

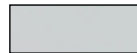

Semi-Opaque Glass



White or Black Back Painted Glass

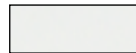

Clear Glass

Insert Finishes

Standard Sizes

- 48" x 80"
- 60" x 80"
- 72" x 80"
- 84" x 80"
- 96" x 80"
- 108" x 80" (3-panel)
- Custom sizes available in both width & height. Additional panels available based on opening width. Contact us for more information

Features & Benefits

- Modern 2" x 1-3/8" extruded aluminum frame is lightweight for a quiet opening and closing action
- Various frame and insert finishes and materials to match your interior decor
- Opening force meets the requirements of ADA
- Precision bearing rollers provide a smooth, quiet slide that has been tested over 100,000 open/close cycles
- North American Made

Specifications

- Clear Mirror | Double-sided 2.8mm with Safety Backing
- White/Black Back Painted Glass | Double-Sided 2.8mm with Safety Backing
- Semi-Opaque Glass | 6mm Frosted Laminated Glass
- Clear Glass | 6mm Frosted Laminated Glass



For order information, product specifications or general questions please contact us:

Call: 1-800-493-5263

Email: info@acme-hardware.com

Website: www.acmehardware.ca

Current Acme customers can access pricing and other marketing materials by visiting our secure customer portal www.MyRenin.com

Acme products may differ slightly from images and specification within our product sheets due to product improvements or manufacturing changes over the life of the product.